

NTMFS4108N

Power MOSFET

30 V, 35 A, Single N-Channel,
SO-8 Flat Lead Package

Features

- Thermally and Electrically Enhanced Packaging Compatible with Standard SO-8 Package Footprint
- New Package Provides Capability of Inspection and Probe After Board Mounting
- Ultra Low $R_{DS(on)}$ (at 4.5 V_{GS}), Low Gate Resistance and Low Q_G
- Optimized for Low Side Synchronous Applications
- High Speed Switching Capability
- These are Pb-Free Devices

Applications

- Notebook Computer V_{core} Applications
- Network Applications
- DC-DC Converters

MAXIMUM RATINGS (T_J = 25°C unless otherwise noted)

| Rating | | | Symbol | Value | Unit |
|---|------------------------|-----------------------|-----------------------------------|----------------|------|
| Drain-to-Source Voltage | | | V _{DSS} | 30 | V |
| Gate-to-Source Voltage | | | V _{GS} | ±20 | V |
| Continuous Drain Current (Note 1) | Steady State | T _A = 25°C | I _D | 22 | A |
| | | T _A = 85°C | | 16 | |
| | t ≤ 10 s | T _A = 25°C | | 35 | |
| Power Dissipation (Note 1) | Steady State | T _A = 25°C | P _D | 2.7 | W |
| | t ≤ 10 s | | | 7.2 | |
| Continuous Drain Current (Note 2) | Steady State | T _A = 25°C | I _D | 13.5 | A |
| | | T _A = 85°C | | 10 | |
| Power Dissipation (Note 2) | Steady State | T _A = 25°C | P _D | 1.1 | W |
| Power Dissipation R _{θJC} (Note 1) | | T _C = 25°C | | P _D | |
| Pulsed Drain Current | t _p = 10 μs | | I _{DM} | 288 | A |
| Operating Junction and Storage Temperature | | | T _J , T _{stg} | -55 to 150 | °C |
| Continuous Source Current (Body Diode) | | | I _S | 6.0 | A |
| Single Pulse Drain-to-Source Avalanche Energy (V _{DD} = 30 V, V _{GS} = 10 V, I _{PK} = 30 A, L = 1 mH, R _G = 25 Ω) | | | E _{AS} | 450 | mJ |
| Lead Temperature for Soldering Purposes (1/8" from case for 10 s) | | | T _L | 260 | °C |

Stresses exceeding Maximum Ratings may damage the device. Maximum Ratings are stress ratings only. Functional operation above the Recommended Operating Conditions is not implied. Extended exposure to stresses above the Recommended Operating Conditions may affect device reliability.

1. Surface-mounted on FR4 board using 1" sq. pad size (Cu area = 650 mm² [1 oz] including traces).
2. Surface-mounted on FR4 board using the minimum recommended pad size (Cu area = 50 mm²).



ON Semiconductor®

<http://onsemi.com>

| V _{(BR)DSS} | R _{DS(on)} TYP | I _D MAX |
|----------------------|-------------------------|--------------------|
| 30 V | 1.8 mΩ @ 10 V | 35 A |
| | 2.7 mΩ @ 4.5 V | |

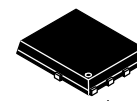
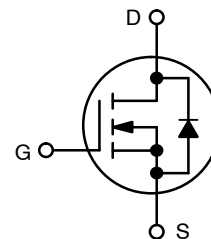

SO-8 FLAT LEAD
CASE 488AA
STYLE 1

MARKING DIAGRAM

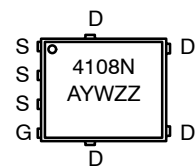

4108N = Specific Device Code
A = Assembly Location
Y = Year
W = Work Week
ZZ = Lot Traceability

ORDERING INFORMATION

| Device | Package | Shipping† |
|---------------|-------------------|------------------|
| NTMFS4108NT1G | SO-8 FL (Pb-Free) | 1500 Tape / Reel |
| NTMFS4108NT3G | SO-8 FL (Pb-Free) | 5000 Tape / Reel |

†For information on tape and reel specifications, including part orientation and tape sizes, please refer to our Tape and Reel Packaging Specification Brochure, BRD8011/D.

NTMFS4108N

THERMAL RESISTANCE RATINGS

| Rating | Symbol | Max | Unit |
|--|-----------------|------|------|
| Junction-to-Case (Drain Terminal) | $R_{\theta JC}$ | 1.3 | °C/W |
| Junction-to-Ambient - Steady State (Note 3) | $R_{\theta JA}$ | 45.7 | |
| Junction-to-Ambient - $t \leq 10$ s (Note 3) | $R_{\theta JA}$ | 17.3 | |
| Junction-to-Ambient - Steady State (Note 4) | $R_{\theta JA}$ | 117 | |

ELECTRICAL CHARACTERISTICS ($T_J = 25^\circ\text{C}$ unless otherwise noted)

| Characteristic | Symbol | Test Condition | Min | Typ | Max | Unit |
|----------------|--------|----------------|-----|-----|-----|------|
|----------------|--------|----------------|-----|-----|-----|------|

OFF CHARACTERISTICS

| | | | | | | |
|---|-------------------|---|---------------------------|----|-----|---------------|
| Drain-to-Source Breakdown Voltage | $V_{(BR)DSS}$ | $V_{GS} = 0$ V, $I_D = 250$ μA | 30 | | | V |
| Drain-to-Source Breakdown Voltage Temperature Coefficient | $V_{(BR)DSS}/T_J$ | | | 21 | | mV/°C |
| Zero Gate Voltage Drain Current | I_{DSS} | $V_{GS} = 0$ V, $V_{DS} = 24$ V | $T_J = 25^\circ\text{C}$ | | 1.0 | μA |
| | | | $T_J = 125^\circ\text{C}$ | | 25 | |
| Gate-to-Source Leakage Current | I_{GSS} | $V_{DS} = 0$ V, $V_{GS} = 20$ V | | | 100 | nA |

ON CHARACTERISTICS (Note 5)

| | | | | | | |
|--|------------------|---|-----|-----|-----|------------|
| Gate Threshold Voltage | $V_{GS(TH)}$ | $V_{GS} = V_{DS}$, $I_D = 250$ μA | 1.0 | | 2.5 | V |
| Negative Threshold Temperature Coefficient | $V_{GS(TH)}/T_J$ | | | 7.5 | | mV/°C |
| Drain-to-Source On Resistance | $R_{DS(on)}$ | $V_{GS} = 4.5$ V, $I_D = 19$ A | | 2.7 | 3.4 | m Ω |
| | | $V_{GS} = 10$ V, $I_D = 21$ A | | 1.8 | 2.2 | |
| Forward Transconductance | g_{FS} | $V_{DS} = 15$ V, $I_D = 10$ A | | 25 | | S |

CHARGES, CAPACITANCES AND GATE RESISTANCE

| | | | | | | |
|------------------------------|--------------|---|--|------|--|----|
| Input Capacitance | C_{ISS} | $V_{GS} = 0$ V, $f = 1.0$ MHz, $V_{DS} = 15$ V | | 6000 | | pF |
| Output Capacitance | C_{OSS} | | | 1200 | | |
| Reverse Transfer Capacitance | C_{RSS} | | | 700 | | |
| Total Gate Charge | $Q_{G(TOT)}$ | $V_{GS} = 4.5$ V, $V_{DS} = 24$ V, $I_D = 21$ A | | 54 | | nC |
| Threshold Gate Charge | $Q_{G(TH)}$ | | | 11 | | |
| Gate-to-Source Charge | Q_{GS} | | | 16 | | |
| Gate-to-Drain Charge | Q_{GD} | | | 23 | | |
| Gate Resistance | R_G | | | 0.7 | | |

SWITCHING CHARACTERISTICS, $V_{GS} = 10$ V (Note 6)

| | | | | | | |
|---------------------|--------------|---|--|-----|--|----|
| Turn-On Delay Time | $t_{d(ON)}$ | $V_{GS} = 4.5$ V, $V_{DS} = 15$ V, $I_D = 1.0$ A, $R_G = 6.0$ Ω | | 45 | | ns |
| Rise Time | t_r | | | 60 | | |
| Turn-Off Delay Time | $t_{d(OFF)}$ | | | 70 | | |
| Fall Time | t_f | | | 140 | | |

DRAIN-SOURCE DIODE CHARACTERISTICS

| | | | | | | | |
|-------------------------|----------|---|---------------------------|--|------|-----|----|
| Forward Diode Voltage | V_{SD} | $V_{GS} = 0$ V, $I_S = 6.0$ A | $T_J = 25^\circ\text{C}$ | | 0.72 | 1.1 | V |
| | | | $T_J = 125^\circ\text{C}$ | | 0.65 | | |
| Reverse Recovery Time | t_{RR} | $V_{GS} = 0$ V, $dI_S/dt = 100$ A/ μs , $I_S = 6.0$ A | | | 41 | | ns |
| Charge Time | t_a | | | | 20 | | |
| Discharge Time | t_b | | | | 21 | | |
| Reverse Recovery Charge | Q_{RR} | | | | 45 | | nC |

- Surface-mounted on FR4 board using 1" sq. pad size (Cu area = 650 mm² [1 oz] including traces).
- Surface-mounted on FR4 board using the minimum recommended pad size (Cu area = 50 mm²).
- Pulse Test: Pulse Width ≤ 300 μs , Duty Cycle $\leq 2\%$.
- Switching characteristics are independent of operating junction temperatures.

TYPICAL PERFORMANCE CURVES

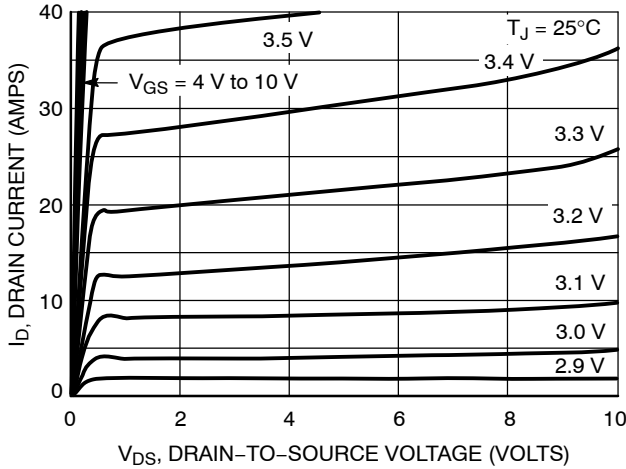

Figure 1. On-Region Characteristics

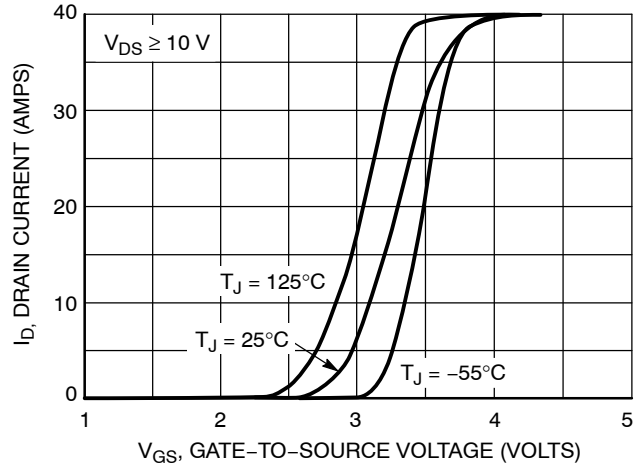

Figure 2. Transfer Characteristics

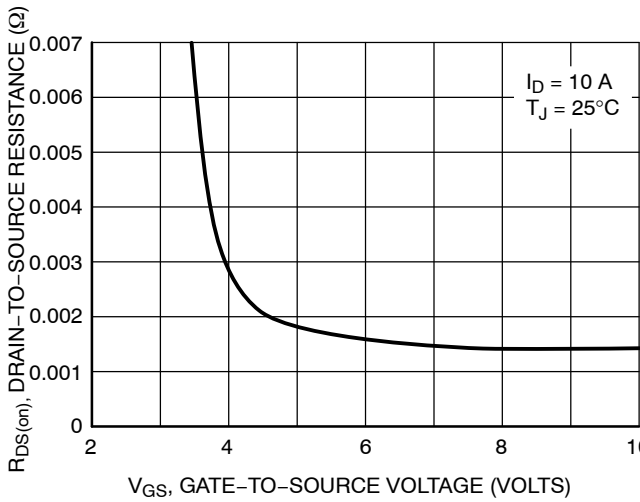

Figure 3. On-Resistance vs. Gate-to-Source Voltage

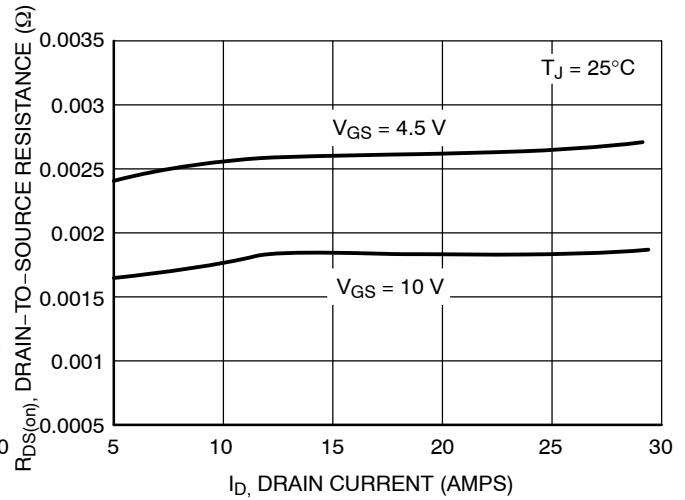

Figure 4. On-Resistance vs. Drain Current and Gate Voltage

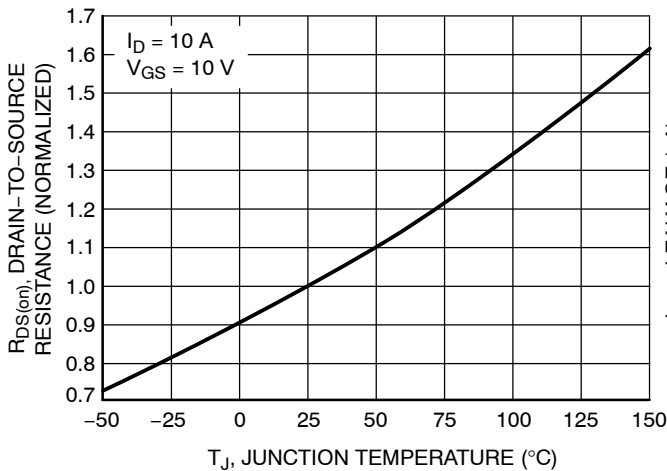

Figure 5. On-Resistance Variation with Temperature

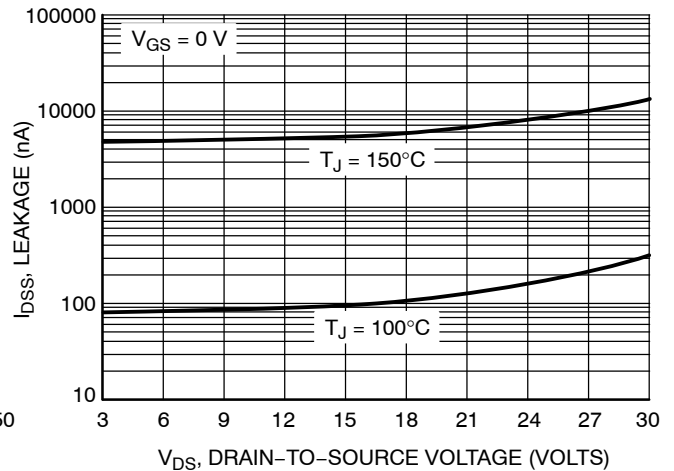

Figure 6. Drain-to-Source Leakage Current vs. Voltage

TYPICAL PERFORMANCE CURVES

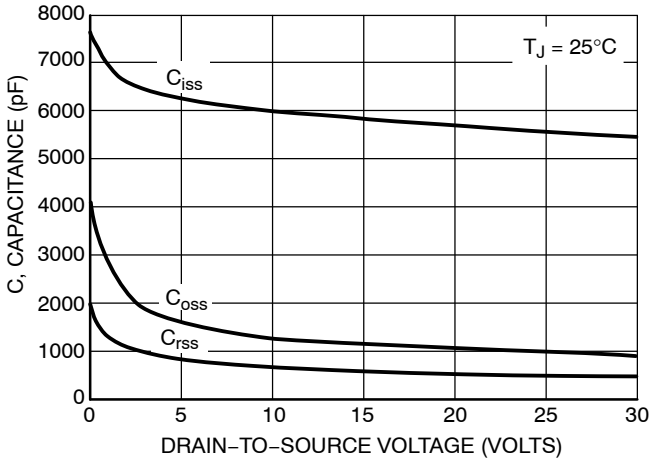

Figure 7. Capacitance Variation

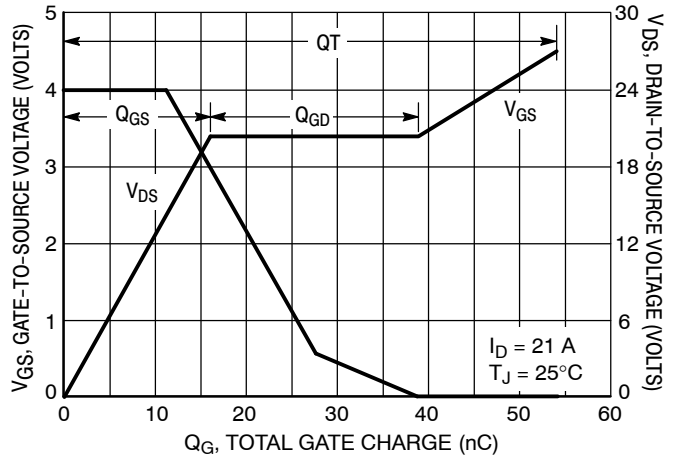

Figure 8. Gate-To-Source and Drain-To-Source Voltage vs. Total Charge

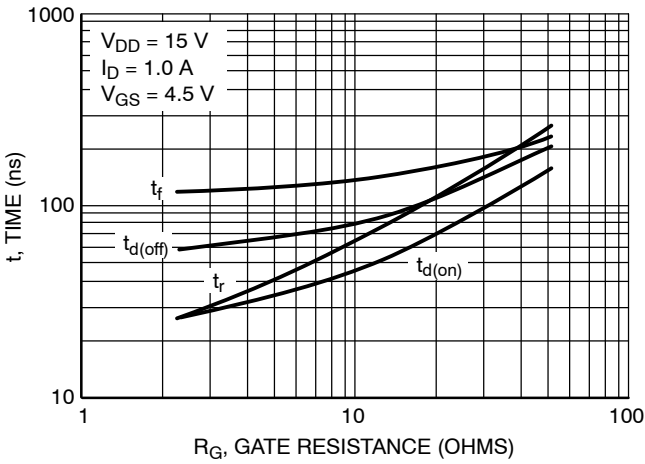

Figure 9. Resistive Switching Time Variation vs. Gate Resistance

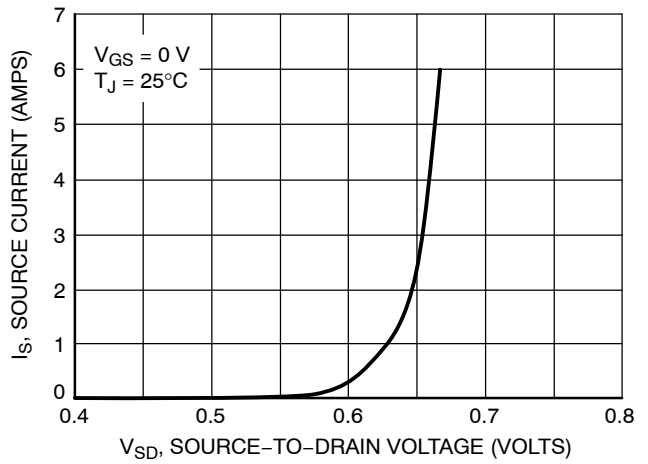

Figure 10. Diode Forward Voltage vs. Current

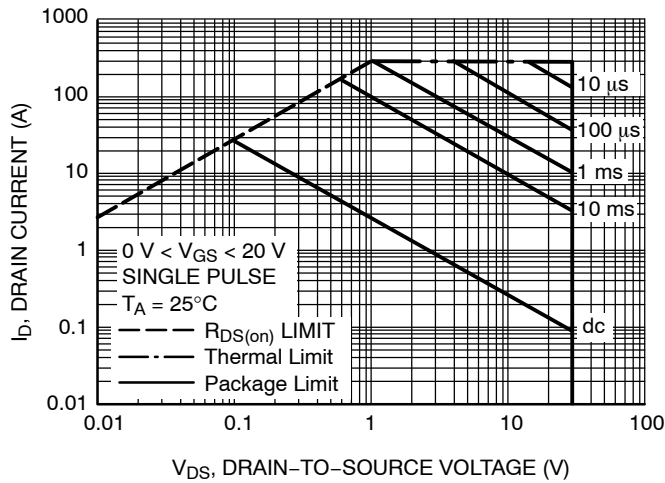

Figure 11. Maximum Rated Forward Biased Safe Operating Area

NTMFS4108N

TYPICAL PERFORMANCE CURVES

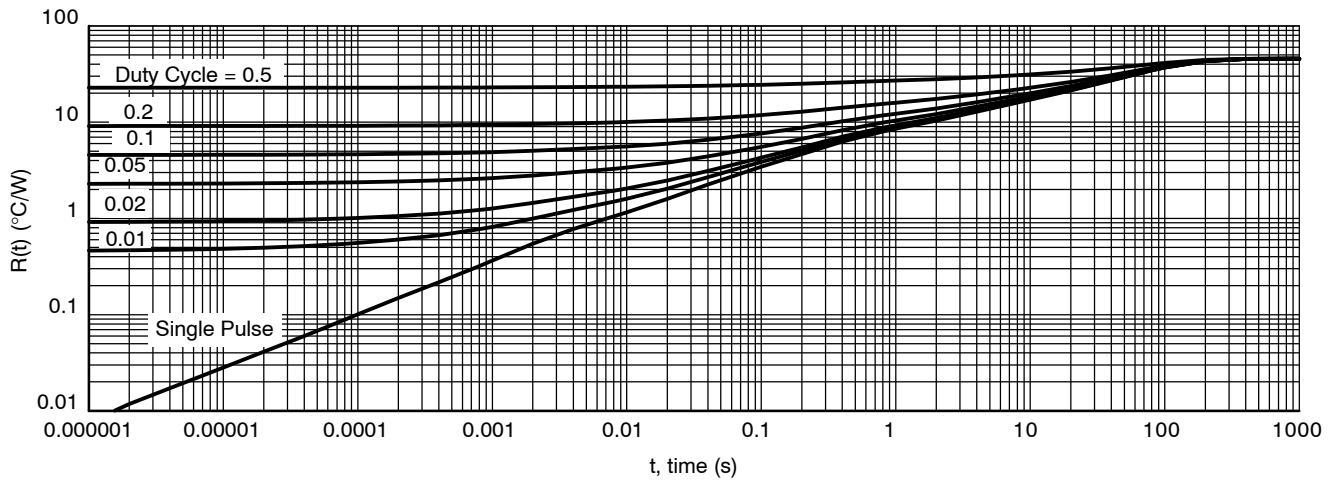
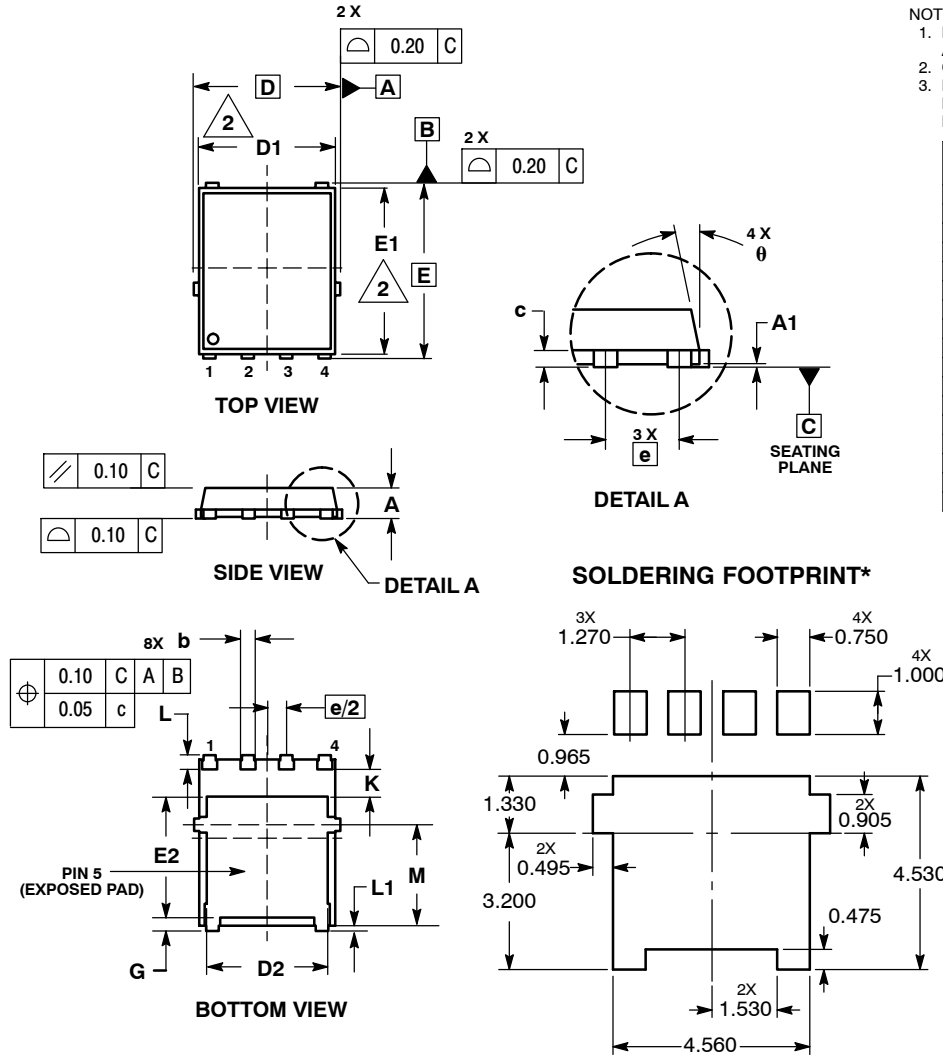

Figure 12. FET Thermal Response

NTMFS4108N

PACKAGE DIMENSIONS

DFN5 5x6, 1.27P
(SO-8FL)
CASE 488AA
ISSUE G



NOTES:

1. DIMENSIONING AND TOLERANCING PER ASME Y14.5M, 1994.
2. CONTROLLING DIMENSION: MILLIMETER.
3. DIMENSION D1 AND E1 DO NOT INCLUDE MOLD FLASH PROTRUSIONS OR GATE BURRS.

| DIM | MILLIMETERS | | |
|-----|-------------|------|------|
| | MIN | NOM | MAX |
| A | 0.90 | 1.00 | 1.10 |
| A1 | 0.00 | --- | 0.05 |
| b | 0.33 | 0.41 | 0.51 |
| c | 0.23 | 0.28 | 0.33 |
| D | 5.15 BSC | | |
| D1 | 4.50 | 4.90 | 5.10 |
| D2 | 3.50 | --- | 4.22 |
| E | 6.15 BSC | | |
| E1 | 5.50 | 5.80 | 6.10 |
| E2 | 3.45 | --- | 4.30 |
| e | 1.27 BSC | | |
| G | 0.51 | 0.61 | 0.71 |
| K | 1.20 | 1.35 | 1.50 |
| L | 0.51 | 0.61 | 0.71 |
| L1 | 0.05 | 0.17 | 0.20 |
| M | 3.00 | 3.40 | 3.80 |
| θ | 0 ° | --- | 12 ° |

STYLE 1:

1. SOURCE
2. SOURCE
3. SOURCE
4. GATE
5. DRAIN

*For additional information on our Pb-Free strategy and soldering details, please download the ON Semiconductor Soldering and Mounting Techniques Reference Manual, SOLDERRM/D.

ON Semiconductor and are registered trademarks of Semiconductor Components Industries, LLC (SCILLC). SCILLC reserves the right to make changes without further notice to any products herein. SCILLC makes no warranty, representation or guarantee regarding the suitability of its products for any particular purpose, nor does SCILLC assume any liability arising out of the application or use of any product or circuit, and specifically disclaims any and all liability, including without limitation special, consequential or incidental damages. "Typical" parameters which may be provided in SCILLC data sheets and/or specifications can and do vary in different applications and actual performance may vary over time. All operating parameters, including "Typicals" must be validated for each customer application by customer's technical experts. SCILLC does not convey any license under its patent rights nor the rights of others. SCILLC products are not designed, intended, or authorized for use as components in systems intended for surgical implant into the body, or other applications intended to support or sustain life, or for any other application in which the failure of the SCILLC product could create a situation where personal injury or death may occur. Should Buyer purchase or use SCILLC products for any such unintended or unauthorized application, Buyer shall indemnify and hold SCILLC and its officers, employees, subsidiaries, affiliates, and distributors harmless against all claims, costs, damages, and expenses, and reasonable attorney fees arising out of, directly or indirectly, any claim of personal injury or death associated with such unintended or unauthorized use, even if such claim alleges that SCILLC was negligent regarding the design or manufacture of the part. SCILLC is an Equal Opportunity/Affirmative Action Employer. This literature is subject to all applicable copyright laws and is not for resale in any manner.

PUBLICATION ORDERING INFORMATION

LITERATURE FULFILLMENT:

Literature Distribution Center for ON Semiconductor
P.O. Box 5163, Denver, Colorado 80217 USA
Phone: 303-675-2175 or 800-344-3860 Toll Free USA/Canada
Fax: 303-675-2176 or 800-344-3867 Toll Free USA/Canada
Email: orderlit@onsemi.com

N. American Technical Support: 800-282-9855 Toll Free
USA/Canada
Europe, Middle East and Africa Technical Support:
Phone: 421 33 790 2910
Japan Customer Focus Center
Phone: 81-3-5817-1050

ON Semiconductor Website: www.onsemi.com

Order Literature: <http://www.onsemi.com/orderlit>

For additional information, please contact your local Sales Representative