

**System pitch 5.08 mm (0.200 inch)
SL-SMT 5.08/04/90G 3.2SN BK BX**

Weidmüller Interface GmbH & Co. KG
Klingenbergstraße 16
D-32758 Detmold
Germany
Fon: +49 5231 14-0
Fax: +49 5231 14-2083
www.weidmueller.com



High-temperature-resistant male connector, packed in box or tape. In tape with 1.5 mm solder pin optimised for automatic assembly. 3.2 mm solder pin suitable for reflow and wave soldering. These male connectors can be labelled and coded.

- 400 V (IEC) / 300 V (UL)
- 19 A (IEC) / 15 A (UL)

General ordering data

Order No.	1780200000
Part designation	SL-SMT 5.08/04/90G 3.2SN BK BX
Version	PCB plug-in connector, male header, 5.08 mm, No. of poles: 4, 90°, Solder pin length: 3.2 mm, tinned, black, Reflow solder connection, Box
GTIN (EAN)	4032248165520
Qty.	100 pc(s).
Packaging	Box

System pitch 5.08 mm (0.200 inch) SL-SMT 5.08/04/90G 3.2SN BK BX

Weidmüller Interface GmbH & Co. KG
Klingenbergstraße 16
D-32758 Detmold
Germany
Fon: +49 5231 14-0
Fax: +49 5231 14-2083
www.weidmueller.com

Technical data

System parameters

Fitted to PCB	Reflow solder connection	Outgoing elbow	90°
Pitch in mm	5.08 mm	Pitch in inch	0.2 inch
No. of poles	4	Solder pin length	3.2 mm
Can be coded	Yes	No. of rows	1
Number of solder pins per pole	1	L1 in mm	15.24 mm
L1 in inch	0.6 inch		

Material data

Insulating material	LCP GF	Colour	black
Insulating material group	IIIa	Flammability class UL 94	V-0
Contact material	CuSn	Contact surface	tinned
Highest continuous operating temperature, min.	-25 °C	Highest continuous operating temperature, max.	100 °C
Max. relative humidity during storage	80 %		

DIN IEC rating data

Rated current, min. No. of poles (Tu=20°C)	19 A	Rated current, max. No. of poles (Tu=20°C)	15 A
Rated current, no. of poles (Tu=40°C), min.	16 A	Rated current, no. of poles (Tu=40°C), max.	13 A
Rated voltage at overvoltage category/pollution degree III/3	250 V	Rated impulse withstand voltage for overvoltage class/pollution severity III/3	4 kV
Rated voltage for overvoltage class/pollution severity III/2	320 V	Rated impulse withstand voltage for overvoltage class/pollution severity III/2	4 kV
Rated voltage for overvoltage class/pollution severity II/2	400 V	Rated impulse withstand voltage for overvoltage class/pollution severity II/2	4 kV

CSA rating data

Rated voltage (Use group B)	300 V	Rated current (use group B)	15 A
Rated voltage (use group D)	300 V	Rated current (use group D)	10 A

UL 1059 rating data

Rated voltage (use group B)	300 V	Rated current (use group B)	15 A
Rated voltage (use group D)	300 V	Rated current (use group D)	10 A

Approvals

Approvals institutes	CSA; GOSTME25; UR; ROHS
----------------------	-------------------------

Classifications

ETIM 3.0	EC001284	eClass 5.1	27-26-07-04
eClass 6.0	27-26-07-04		

Datasheet

System pitch 5.08 mm (0.200 inch)
SL-SMT 5.08/04/90G 3.2SN BK BX

Weidmüller Interface GmbH & Co. KG
Klingenbergstraße 16
D-32758 Detmold
Germany
Fon: +49 5231 14-0
Fax: +49 5231 14-2083
www.weidmueller.com

Technical data**Notes**

Notes

- Additional colours on request
- Gold-plated contact surfaces on request
- Rated current related to rated cross-section and min. No. of poles.
- Diameter of solder eyelet $D = 1.4 \pm 0.1$ mm
- Diameter of solder eyelet $D = 1.5 \pm 0.1$ mm from 9-pole
- P on drg. = pitch
- Rated data refer only to the component itself. Clearance and creepage distances to other components are to be designed in accordance with the relevant application standards.

Datasheet

**System pitch 5.08 mm (0.200 inch)
SL-SMT 5.08/04/90G 3.2SN BK BX**

Weidmüller Interface GmbH & Co. KG
Klingenbergstraße 16
D-32758 Detmold
Germany
Fon: +49 5231 14-0
Fax: +49 5231 14-2083
www.weidmueller.com

Drawings

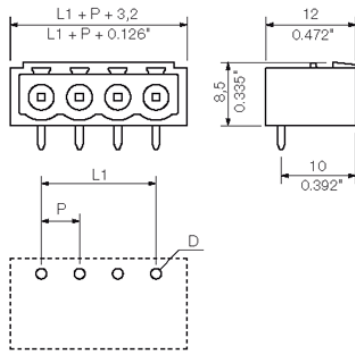

System pitch 5.08 mm (0.200 inch) SL-SMT 5.08/04/90G 3.2SN BK BX

Weidmüller Interface GmbH & Co. KG
 Klingenbergstraße 16
 D-32758 Detmold
 Germany
 Fon: +49 5231 14-0
 Fax: +49 5231 14-2083
 www.weidmueller.com

Counterpart

BLZ 5.08F QV2



Female connectors with clamping yoke screw connection for conductor connection with straight outlet direction and internal cross-connection for connections 1-2 & 3-4. Bus current up to 32 A for 4 mm² (without wire end ferrules). The female connectors provide space for labelling and can be coded. Packed in cardboard box.

- 0.20 - 2.5 mm² (IEC) / 26 - 14 AWG (UL)
- 400 V (IEC) / 300 V (UL)
- 17.5 A (IEC) / 10 A (UL)

General ordering data

Order No.	Part designation	Version	GTIN (EAN)	Qty.	Packaging
1844500000	BLZ 5.08/04/180FQV2 SN BK BX	PCB plug-in connector, female plug, 5.08 mm, No. of poles: 4, 180°, Clamping yoke connection, Clamping range, max.: 4 mm ² , Box	4032248354948	100 pc(s).	Box
1846870000	BLZ 5.08/04/180FQV2 SN OR BX	PCB plug-in connector, female plug, 5.08 mm, No. of poles: 4, 180°, Clamping yoke connection, Clamping range, max.: 4 mm ² , Box	4032248362684	100 pc(s).	Box

BLZP 5.08/225 SN



Clamping-yoke wire connection with right-angled (90° or 270°) or angled (225°) outlet direction. The female connectors provide space for labelling and can be coded. Can be fastened with flange or release latch. They feature an integrated plus/minus screw, protection against false insertion under clamping yoke. They are delivered with an opened clamping yoke.

- 0.2-2.5 mm² (IEC) / 26-12 AWG (UL)
- 400 V (IEC) / 300 V (UL)
- 17.5 A (IEC) / 10 A (UL)

General ordering data

Order No.	Part designation	Version	GTIN (EAN)	Qty.	Packaging
1946270000	BLZP 5.08/04/225 SN OR BX	PCB plug-in connector, female plug, 5.08 mm, No. of poles: 4, 225°, Clamping yoke connection, Clamping range, max.: 4 mm ² , Box	4032248621842	90 pc(s).	Box
1946580000	BLZP 5.08/04/225 SN BK BX	PCB plug-in connector, female plug, 5.08 mm, No. of poles: 4, 225°, Clamping yoke connection, Clamping range, max.: 4 mm ² , Box	4032248622351	90 pc(s).	Box

System pitch 5.08 mm (0.200 inch) SL-SMT 5.08/04/90G 3.2SN BK BX

Weidmüller Interface GmbH & Co. KG
 Klingenbergstraße 16
 D-32758 Detmold
 Germany
 Fon: +49 5231 14-0
 Fax: +49 5231 14-2083
 www.weidmueller.com

Counterpart

BLZP 5.08/180 SN



Female connectors with clamping yoke screw connection for conductor connection with straight (180°) outlet direction. The female connectors provide space for labelling and can be coded. Can be fastened with flange or release latch. They feature an integrated plus/minus screw, protection against false insertion under clamping yoke. They are delivered with an opened clamping yoke.

- 0.2-2.5 mm² (IEC) / 26-12 AWG (UL)
- 400 V (IEC) / 300 V (UL)
- 19 A (IEC) / 15 A (UL)

General ordering data

Order No.	Part designation	Version	GTIN (EAN)	Qty.	Packaging
1943600000	BLZP 5.08/04/180 SN OR BX	PCB plug-in connector, female plug, 5.08 mm, No. of poles: 4, 180°, Clamping yoke connection, Clamping range, max.: 4 mm ² , Box	4032248617593	100 pc(s).	Box
1943830000	BLZP 5.08/04/180 SN BK BX	PCB plug-in connector, female plug, 5.08 mm, No. of poles: 4, 180°, Clamping yoke connection, Clamping range, max.: 4 mm ² , Box	4032248617869	100 pc(s).	Box

BLF 5.08/90 SN



Just as reliable as the tried-and-true original, with innovation in detail:

The BLF 5.0x – the PUSH-IN version of the BLZ 5.0x socket block – features a new connection system and a more compact design. Weidmüller's innovative PUSH-IN spring connection features a trend-setting, tool-free wire connection system that is simple to operate.

In terms of versatility, the BLF 5.0x offers just as much as the older versions:

- The choice of three wire outlet directions offers you proven design flexibility for your applications.
- Four flange variations, including the patented release latch, allow for user-friendly unplugging designs.

General ordering data

Order No.	Part designation	Version	GTIN (EAN)	Qty.	Packaging
1001550000	BLF 5.08/04/90 SN OR BX	PCB plug-in connector, female plug, 5.08 mm, No. of poles: 4, 90°, PUSH IN, Clamping range, max.: 3.31 mm ² , Box	4032248693351	90 pc(s).	Box
1000050001	BLF 5.08/04/90 SN BK BX	PCB plug-in connector, female plug, 5.08 mm, No. of poles: 4, 90°, PUSH IN, Clamping range, max.: 3.31 mm ² , Box	4032248689989	90 pc(s).	Box

System pitch 5.08 mm (0.200 inch) SL-SMT 5.08/04/90G 3.2SN BK BX

Weidmüller Interface GmbH & Co. KG
 Klingenbergstraße 16
 D-32758 Detmold
 Germany
 Fon: +49 5231 14-0
 Fax: +49 5231 14-2083
 www.weidmueller.com

Counterpart

BLZP 5.00/270 SN

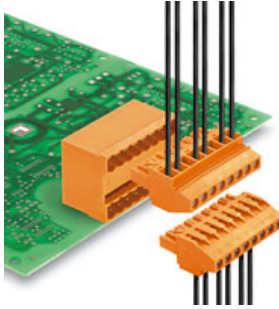

Socket connectors with clamping yoke screw connection for conductor connection with a right-angle (90° or 270°) outlet direction. The female connectors provide space for labelling and can be coded. Can be fastened with flange or release latch. They feature an integrated plus/minus screw, protection against false insertion under clamping yoke. They are delivered with an opened clamping yoke.

- 0.2-2.5 mm² (IEC) / 26-12 AWG (UL)
- 400 V (IEC) / 300 V (UL)
- 15 A (IEC) / 10 A (UL)

General ordering data

Order No.	Part designation	Version	GTIN (EAN)	Qty.	Packaging
1959080000	BLZP 5.00/04/270 SN BK BX	PCB plug-in connector, female plug, 5.00 mm, No. of poles: 4, 90°, Clamping yoke connection, Clamping range, max.: 4 mm ² , Box	4032248638017	90 pc(s).	Box
1958850000	BLZP 5.00/04/270 SN OR BX	PCB plug-in connector, female plug, 5.00 mm, No. of poles: 4, 90°, Clamping yoke connection, Clamping range, max.: 4 mm ² , Box	4032248637683	90 pc(s).	Box

BLZ 5.00/270



Female connectors with clamping yoke screw connection. The female connectors provide space for labelling and can be coded. Packed in cardboard box.

- 0.20 - 2.5 mm² (IEC) / 26 - 12 AWG (UL)
- 400 V (IEC) / 300 V (UL)
- 15 A (IEC) / 10 A (UL)

General ordering data

Order No.	Part designation	Version	GTIN (EAN)	Qty.	Packaging
1637830000	BLZ 5.00/04/270 SN BK BX	PCB plug-in connector, female plug, 5.00 mm, No. of poles: 4, 270°, Clamping yoke connection, Clamping range, max.: 3.31 mm ² , Box	4008190275075	90 pc(s).	Box
1637600000	BLZ 5.00/04/270 SN OR BX	PCB plug-in connector, female plug, 5.00 mm, No. of poles: 4, 270°, Clamping yoke connection, Clamping range, max.: 3.31 mm ² , Box	4008190274849	90 pc(s).	Box

System pitch 5.08 mm (0.200 inch) SL-SMT 5.08/04/90G 3.2SN BK BX

Weidmüller Interface GmbH & Co. KG
 Klingenbergstraße 16
 D-32758 Detmold
 Germany
 Fon: +49 5231 14-0
 Fax: +49 5231 14-2083
 www.weidmueller.com

Counterpart

BLL 5.08/180



Female connector for PCB mounting. The solder pin length is optimised for wave flow soldering. Packed in cardboard box.

- 400 V (IEC) / 300 V (UL)
- 23 A (IEC) / 15 A (UL)

General ordering data

Order No.	Part designation	Version	GTIN (EAN)	Qty.	Packaging
1630730000	BLL 5.08/04/180 3.2SN OR BX	PCB plug-in connector, female header, 5.08 mm, No. of poles: 4, 180°, Solder pin length: 3.2 mm, tinned, Orange, Solder connection, Box	4008190204150	100 pc(s).	Box

BLZF 5.08/180



Female connectors for connecting conductors with tension clamp system, straight 180° outlet direction. The female connectors include space for labelling and can be coded. Packed in cardboard box.

- 0.20 - 2.5 mm² (IEC) / 26 - 12 AWG (UL)
- 400 V (IEC) / 300 V (UL)
- 17 A (IEC) / 15 A (UL)

General ordering data

Order No.	Part designation	Version	GTIN (EAN)	Qty.	Packaging
1707480000	BLZF 5.08/04/180 SN OR BX	PCB plug-in connector, female plug, 5.08 mm, No. of poles: 4, 180°, Tension clamp connection, Clamping range, max.: 3.31 mm ² , Box	4008190395858	90 pc(s).	Box
1707710000	BLZF 5.08/04/180 SN BK BX	PCB plug-in connector, female plug, 5.08 mm, No. of poles: 4, 180°, Tension clamp connection, Clamping range, max.: 3.31 mm ² , Box	4008190316716	90 pc(s).	Box

System pitch 5.08 mm (0.200 inch) SL-SMT 5.08/04/90G 3.2SN BK BX

Weidmüller Interface GmbH & Co. KG
 Klingenbergstraße 16
 D-32758 Detmold
 Germany
 Fon: +49 5231 14-0
 Fax: +49 5231 14-2083
 www.weidmueller.com

Counterpart

BLF 5.00/90 SN



Just as reliable as the tried-and-true original, with innovation in detail:

The BLF 5.0x – the PUSH-IN version of the BLZ 5.0x socket block – features a new connection system and a more compact design. Weidmüller's innovative PUSH-IN spring connection features a trend-setting, tool-free wire connection system that is simple to operate.

In terms of versatility, the BLF 5.0x offers just as much as the older versions:

- The choice of three wire outlet directions offers you proven design flexibility for your applications.
- Four flange variations, including the patented release latch, allow for user-friendly unplugging designs.

General ordering data

Order No.	Part designation	Version	GTIN (EAN)	Qty.	Packaging
1980190000	BLF 5.00/04/90 SN OR BX	PCB plug-in connector, female plug, 5.00 mm, No. of poles: 4, 90°, PUSH IN, Clamping range, max.: 3.31 mm², Box	4032248675272	90 pc(s).	Box
1979290000	BLF 5.00/04/90 SN BK BX	PCB plug-in connector, female plug, 5.00 mm, No. of poles: 4, 90°, PUSH IN, Clamping range, max.: 3.31 mm², Box	4032248674473	90 pc(s).	Box

BLIDC 5.08



Female connectors for conductor connection with IDC system. The female connectors provide space for labelling and can be coded. Packed in cardboard box.

- 0.35 - 0.75 mm² (IEC) / 22 - 20 AWG (UL)
- 400 V (IEC) / 300 V (UL)
- 11 A (IEC) / 5 A (UL)

General ordering data

Order No.	Part designation	Version	GTIN (EAN)	Qty.	Packaging
1724960000	BLIDC 5.08/04/180 SN OR BX	PCB plug-in connector, female plug, 5.08 mm, No. of poles: 4, 180°, IDC terminal, Clamping range, max.: 0.75 mm², Box	4008190377304	100 pc(s).	Box

System pitch 5.08 mm (0.200 inch) SL-SMT 5.08/04/90G 3.2SN BK BX

Weidmüller Interface GmbH & Co. KG
 Klingenbergstraße 16
 D-32758 Detmold
 Germany
 Fon: +49 5231 14-0
 Fax: +49 5231 14-2083
 www.weidmueller.com

Counterpart

BLZP 5.00/90 SN



Socket connectors with clamping yoke screw connection for conductor connection with a right-angle (90° or 270°) outlet direction. The female connectors provide space for labelling and can be coded. Can be fastened with flange or release latch. They feature an integrated plus/minus screw, protection against false insertion under clamping yoke. They are delivered with an opened clamping yoke.

- 0.2-2.5 mm² (IEC) / 26-12 AWG (UL)
- 400 V (IEC) / 300 V (UL)
- 15 A (IEC) / 10 A (UL)

General ordering data

Order No.	Part designation	Version	GTIN (EAN)	Qty.	Packaging
1958280000	BLZP 5.00/04/90 SN OR BX	PCB plug-in connector, female plug, 5.00 mm, No. of poles: 4, 90°, Clamping yoke connection, Clamping range, max.: 4 mm ² , Box	4032248637140	90 pc(s).	Box
1958630000	BLZP 5.00/04/90 SN BK BX	PCB plug-in connector, female plug, 5.00 mm, No. of poles: 4, 90°, Clamping yoke connection, Clamping range, max.: 4 mm ² , Box	4032248637362	90 pc(s).	Box

BLZ 5.00/90



Female connectors with clamping yoke screw connection. The female connectors provide space for labelling and can be coded. Packed in cardboard box.

- 0.20 - 2.5 mm² (IEC) / 26 - 12 AWG (UL)
- 400 V (IEC) / 300 V (UL)
- 15 A (IEC) / 10 A (UL)

General ordering data

Order No.	Part designation	Version	GTIN (EAN)	Qty.	Packaging
1635960000	BLZ 5.00/04/90 SN OR BX	PCB plug-in connector, female plug, 5.00 mm, No. of poles: 4, 90°, Clamping yoke connection, Clamping range, max.: 3.31 mm ² , Box	4008190265830	90 pc(s).	Box
1636910000	BLZ 5.00/04/90 SN BK BX	PCB plug-in connector, female plug, 5.00 mm, No. of poles: 4, 90°, Clamping yoke connection, Clamping range, max.: 3.31 mm ² , Box	4008190274153	90 pc(s).	Box

System pitch 5.08 mm (0.200 inch) SL-SMT 5.08/04/90G 3.2SN BK BX

Weidmüller Interface GmbH & Co. KG
 Klingenbergstraße 16
 D-32758 Detmold
 Germany
 Fon: +49 5231 14-0
 Fax: +49 5231 14-2083
 www.weidmueller.com

Counterpart

BLZF 5.08/90



Female connectors for connecting conductors with tension clamp system. The female connectors include space for labelling and can be coded. Packed in cardboard box.

- 0.20 - 2.5 mm² (IEC) / 26 - 12 AWG (UL)
- 400 V (IEC) / 300 V (UL)
- 16.5 A (IEC) / 10 A (UL)

General ordering data

Order No.	Part designation	Version	GTIN (EAN)	Qty.	Packaging
1671040000	BLZF 5.08/04/90 SN BK BX	PCB plug-in connector, female plug, 5.08 mm, No. of poles: 4, 90°, Tension clamp connection, Clamping range, max.: 3.31 mm ² , Box	4008190432713	90 pc(s).	Box
1670810000	BLZF 5.08/04/90 SN OR BX	PCB plug-in connector, female plug, 5.08 mm, No. of poles: 4, 90°, Tension clamp connection, Clamping range, max.: 3.31 mm ² , Box	4008190432416	90 pc(s).	Box

BL 5.00



Female connectors for conductor connection in leaf spring system. Packed in cardboard box. The female connectors provide space for labelling. Packed in cardboard box.

- 0.2 - 1.5 mm² (IEC) / 26 - 14 AWG (UL)
- 400 V (IEC) / 300 V (UL)
- 11 A (IEC) / 10 A (UL)

General ordering data

Order No.	Part designation	Version	GTIN (EAN)	Qty.	Packaging
1730720000	BL 5.00/04/180 SN BK BX	PCB plug-in connector, female plug, 5.00 mm, No. of poles: 4, 180°, Leaf spring connection, Clamping range, max.: 2.08 mm ² , Box	4008190387310	100 pc(s).	Box
1723130000	BL 5.00/04/180 SN OR BX	PCB plug-in connector, female plug, 5.00 mm, No. of poles: 4, 180°, Leaf spring connection, Clamping range, max.: 2.08 mm ² , Box	4032248002535	100 pc(s).	Box
1762790000	BL 5.00/04/180 SN GY BX	PCB plug-in connector, female plug, 5.00 mm, No. of poles: 4, 180°, Leaf spring connection,	4032248048700	100 pc(s).	Box

System pitch 5.08 mm (0.200 inch) SL-SMT 5.08/04/90G 3.2SN BK BX

Weidmüller Interface GmbH & Co. KG
 Klingenbergstraße 16
 D-32758 Detmold
 Germany
 Fon: +49 5231 14-0
 Fax: +49 5231 14-2083
 www.weidmueller.com

Counterpart

Clamping range, max.: 2.08
 mm², Box

BLZP 5.00/180 SN



Female connectors with clamping yoke screw connection for conductor connection with straight (180°) outlet direction. The female connectors provide space for labelling and can be coded. Can be fastened with flange or release latch. They feature an integrated plus/minus screw, protection against false insertion under clamping yoke. They are delivered with an opened clamping yoke.

- 0.2-2.5 mm² (IEC) / 26-12 AWG (UL)
- 400 V (IEC) / 300 V (UL)
- 19 A (IEC) / 15 A (UL)

General ordering data

Order No.	Part designation	Version	GTIN (EAN)	Qty.	Packaging
1955550000	BLZP 5.00/04/180 SN BK BX	PCB plug-in connector, female plug, 5.00 mm, No. of poles: 4, 180°, Clamping yoke connection, Clamping range, max.: 4 mm ² , Box	4032248634040	100 pc(s).	Box

BLIDC 5.08B



Female connectors for conductor connection with IDC system. The female connectors provide space for labelling and can be coded. Packed in cardboard box.

- 0.35 - 0.75 mm² (IEC) / 22 - 20 AWG (UL)
- 400 V (IEC) / 300 V (UL)
- 11 A (IEC) / 5 A (UL)

General ordering data

Order No.	Part designation	Version	GTIN (EAN)	Qty.	Packaging
1759630000	BLIDC 5.08/04/180B SN BK BX	PCB plug-in connector, female plug, 5.08 mm, No. of poles: 4, 180°, IDC terminal, Clamping range, max.: 0.75 mm ² , Box	4032248069866	100 pc(s).	Box

System pitch 5.08 mm (0.200 inch) SL-SMT 5.08/04/90G 3.2SN BK BX

Weidmüller Interface GmbH & Co. KG
 Klingenbergstraße 16
 D-32758 Detmold
 Germany
 Fon: +49 5231 14-0
 Fax: +49 5231 14-2083
 www.weidmueller.com

Counterpart

BLZP 5.08/270 SN

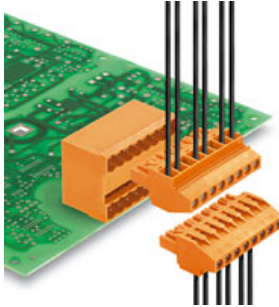

Socket connectors with clamping yoke screw connection for conductor connection with a right-angle (90° or 270°) outlet direction. The female connectors provide space for labelling and can be coded. Can be fastened with flange or release latch. They feature an integrated plus/minus screw, protection against false insertion under clamping yoke. They are delivered with an opened clamping yoke.

- 0.2-2.5 mm² (IEC) / 26-12 AWG (UL)
- 400 V (IEC) / 300 V (UL)
- 15 A (IEC) / 10 A (UL)

General ordering data

Order No.	Part designation	Version	GTIN (EAN)	Qty.	Packaging
1949040000	BLZP 5.08/04/270 SN BK BX	PCB plug-in connector, female plug, 5.08 mm, No. of poles: 4, 270°, Clamping yoke connection, Clamping range, max.: 4 mm ² , Box	4032248626496	90 pc(s).	Box
1948810000	BLZP 5.08/04/270 SN OR BX	PCB plug-in connector, female plug, 5.08 mm, No. of poles: 4, 270°, Clamping yoke connection, Clamping range, max.: 4 mm ² , Box	4032248626267	90 pc(s).	Box

BLZFS 5.00/180



Female connectors for connecting conductors with tension clamp system, straight 180° outlet direction in thin-element design. The female connectors include space for labelling and can be coded. Packed in cardboard box.

- 0.20 - 2.5 mm² (IEC) / 26 - 14 AWG (UL)
- 400 V (IEC) / 300 V (UL)
- 17 A (IEC) / 10 A (UL)

General ordering data

Order No.	Part designation	Version	GTIN (EAN)	Qty.	Packaging
1696620000	BLZFS 5.00/04/180 SN BK BX	PCB plug-in connector, female plug, 5.00 mm, No. of poles: 4, 180°, Tension clamp connection, Clamping range, max.: 2.5 mm ² , Box	4008190878641	100 pc(s).	Box
1696390000	BLZFS 5.00/04/180 SN OR BX	PCB plug-in connector, female plug, 5.00 mm, No. of poles: 4, 180°, Tension clamp connection, Clamping range, max.: 2.5 mm ² , Box	4008190878412	100 pc(s).	Box

System pitch 5.08 mm (0.200 inch) SL-SMT 5.08/04/90G 3.2SN BK BX

Weidmüller Interface GmbH & Co. KG
 Klingenbergstraße 16
 D-32758 Detmold
 Germany
 Fon: +49 5231 14-0
 Fax: +49 5231 14-2083
 www.weidmueller.com

Counterpart

BL 5.08



Female connectors for conductor connection in leaf spring system. Packed in cardboard box. The female connectors provide space for labelling. Packed in cardboard box.

- 0.2 - 1.5 mm² (IEC) / 26 - 14 AWG (UL)
- 400 V (IEC) / 300 V (UL)
- 11 A (IEC) / 10 A (UL)

General ordering data

Order No.	Part designation	Version	GTIN (EAN)	Qty.	Packaging
1716490000	BL 5.08/04/180 SN BK BX	PCB plug-in connector, female plug, 5.08 mm, No. of poles: 4, 180°, Leaf spring connection, Clamping range, max.: 2.08 mm ² , Box	4008190376536	100 pc(s).	Box
1723850000	BL 5.08/04/180 SN DKGX BX	PCB plug-in connector, female plug, 5.08 mm, No. of poles: 4, 180°, Leaf spring connection, Clamping range, max.: 2.08 mm ² , Box	4008190376215	100 pc(s).	Box
1716340000	BL 5.08/04/180 SN OR BX	PCB plug-in connector, female plug, 5.08 mm, No. of poles: 4, 180°, Leaf spring connection, Clamping range, max.: 2.08 mm ² , Box	4008190376376	100 pc(s).	Box

BLZ 5.00/180



Female connectors with clamping yoke screw connection for conductor connection with straight outlet direction. The female connectors provide space for labelling and can be coded. Packed in cardboard box.

- 0.20 - 2.5 mm² (IEC) / 26 - 12 AWG (UL)
- 400 V (IEC) / 300 V (UL)
- 19 A (IEC) / 15 A (UL)

General ordering data

Order No.	Part designation	Version	GTIN (EAN)	Qty.	Packaging
1596080000	BLZ 5.00/04/180 SN BK BX	PCB plug-in connector, female plug, 5.00 mm, No. of poles: 4, 180°, Clamping yoke connection, Clamping range, max.: 3.31 mm ² , Box	4008190176716	100 pc(s).	Box
1571370000	BLZ 5.00/04/180 SN OR BX	PCB plug-in connector, female plug, 5.00 mm, No. of poles: 4, 180°, Clamping yoke	4008190050641	100 pc(s).	Box

System pitch 5.08 mm (0.200 inch) SL-SMT 5.08/04/90G 3.2SN BK BX

Weidmüller Interface GmbH & Co. KG
 Klingenbergstraße 16
 D-32758 Detmold
 Germany
 Fon: +49 5231 14-0
 Fax: +49 5231 14-2083
 www.weidmueller.com

Counterpart

connection, Clamping range,
 max.: 3.31 mm², Box

BLT 5.08

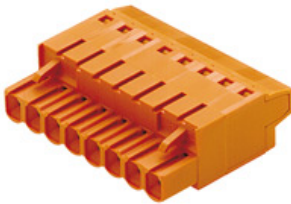

Female connectors with TOP screw system for connecting conductors with straight 180° outlet direction. The female connectors include space for labelling and can be coded. Packed in cardboard box.

- 0.20 - 2.5 mm² (IEC) / 26 - 14 AWG (UL)
- 400 V (IEC) / 300 V (UL)
- 17 A (IEC) / 10 A (UL)

General ordering data

Order No.	Part designation	Version	GTIN (EAN)	Qty.	Packaging
1499760000	BLT 5.08/04/180 SN OR BX	PCB plug-in connector, female plug, 5.08 mm, No. of poles: 4, 180°, TOP connection, Clamping range, max.: 2.5 mm ² , Box	4008190037536	90 pc(s).	Box
1499710000	BLT 5.08/04/180 SN BK BX	PCB plug-in connector, female plug, 5.08 mm, No. of poles: 4, 180°, TOP connection, Clamping range, max.: 2.5 mm ² , Box	4008190861711	90 pc(s).	Box

BLC 5.08R

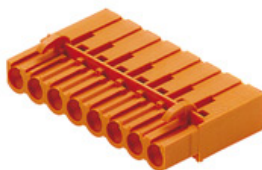

Female connectors for conductor connection with crimp connection system. The female connectors provide space for labelling and can be coded. Packed in cardboard box.

- 0.25 - 2.5 mm² (IEC) / 26 - 14 AWG (UL)
- 400 V (IEC) / 300 V (UL)
- 21 A (IEC) / 10 A (UL)

General ordering data

Order No.	Part designation	Version	GTIN (EAN)	Qty.	Packaging
1610510000	BLC 5.08/04/180R OR BX	PCB plug-in connector, female plug, 5.08 mm, No. of poles: 4, 180°, Crimp connection, Clamping range, max.: 2.5 mm ² , Box	4008190065102	100 pc(s).	Box
1711980000	BLC 5.08/04/180R BK BX	PCB plug-in connector, female plug, 5.08 mm, No. of poles: 4, 180°, Crimp connection,	4008190934996	100 pc(s).	Box

System pitch 5.08 mm (0.200 inch) SL-SMT 5.08/04/90G 3.2SN BK BX

Weidmüller Interface GmbH & Co. KG
 Klingenbergstraße 16
 D-32758 Detmold
 Germany
 Fon: +49 5231 14-0
 Fax: +49 5231 14-2083
 www.weidmueller.com

Counterpart

Clamping range, max.: 2.5
mm², Box

BLZ 5.08/180



Female connectors with clamping yoke screw connection for conductor connection with straight outlet direction. The female connectors provide space for labelling and can be coded. Packed in cardboard box.

- 0.20 - 2.5 mm² (IEC) / 26 - 12 AWG (UL)
- 400 V (IEC) / 300 V (UL)
- 19 A (IEC) / 15 A (UL)

General ordering data

Order No.	Part designation	Version	GTIN (EAN)	Qty.	Packaging
1526610000	BLZ 5.08/04/180 SN BK BX	PCB plug-in connector, female plug, 5.08 mm, No. of poles: 4, 180°, Clamping yoke connection, Clamping range, max.: 3.31 mm², Box	4008190049454	100 pc(s).	Box
1526660000	BLZ 5.08/04/180 SN OR BX	PCB plug-in connector, female plug, 5.08 mm, No. of poles: 4, 180°, Clamping yoke connection, Clamping range, max.: 3.31 mm², Box	4008190148232	100 pc(s).	Box

BLDT 5.08



Female connectors with two clamping yoke screw connections per pole for conductor connection with 90° & 270° outlet direction. The female connectors provide space for labelling and can be coded. Packed in cardboard box.

- 0.20 - 2.5 mm² (IEC) / 26 - 12 AWG (UL)
- 400 V (IEC) / 300 V (UL)
- 14 A (IEC) / 10 A (UL)

General ordering data

Order No.	Part designation	Version	GTIN (EAN)	Qty.	Packaging
1644750000	BLDT 5.08/04/- SN OR BX	PCB plug-in connector, female plug, 5.08 mm, No. of poles: 4, 90°/270°, Clamping yoke connection, Clamping range, max.: 3.31 mm², Box	4008190283964	50 pc(s).	Box
1660730000	BLDT 5.08/04/- SN BK BX	PCB plug-in connector, female plug, 5.08 mm, No. of poles: 4, 90°/270°, Clamping yoke	4008190417185	50 pc(s).	Box

System pitch 5.08 mm (0.200 inch) SL-SMT 5.08/04/90G 3.2SN BK BX

Weidmüller Interface GmbH & Co. KG
 Klingenbergstraße 16
 D-32758 Detmold
 Germany
 Fon: +49 5231 14-0
 Fax: +49 5231 14-2083
 www.weidmueller.com

Counterpart

connection, Clamping range,
 max.: 3.31 mm², Box

BLZ 5.08/90

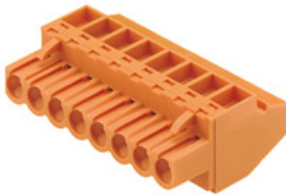

Female connectors with clamping yoke screw connection. The female connectors provide space for labelling and can be coded. Packed in cardboard box.

- 0.20 - 2.5 mm² (IEC) / 26 - 12 AWG (UL)
- 400 V (IEC) / 300 V (UL)
- 15 A (IEC) / 10 A (UL)

General ordering data

Order No.	Part designation	Version	GTIN (EAN)	Qty.	Packaging
1552910000	BLZ 5.08/04/90 SN BK BX	PCB plug-in connector, female plug, 5.08 mm, No. of poles: 4, 90°, Clamping yoke connection, Clamping range, max.: 3.31 mm ² , Box	4008190267728	90 pc(s).	Box
1552960000	BLZ 5.08/04/90 SN OR BX	PCB plug-in connector, female plug, 5.08 mm, No. of poles: 4, 90°, Clamping yoke connection, Clamping range, max.: 3.31 mm ² , Box	4008190123932	90 pc(s).	Box

BLZ 5.08 QV2

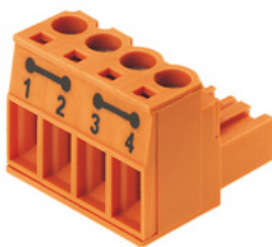

Female connectors with clamping yoke screw connection for conductor connection with straight outlet direction and internal cross-connection for connections 1-2 & 3-4. Bus current up to 32 A for 4 mm² (without wire end ferrules). The female connectors provide space for labelling and can be coded. Packed in cardboard box.

- 0.20 - 2.5 mm² (IEC) / 26 - 14 AWG (UL)
- 400 V (IEC) / 300 V (UL)
- 17.5 A (IEC) / 10 A (UL)

General ordering data

Order No.	Part designation	Version	GTIN (EAN)	Qty.	Packaging
1839770000	BLZ 5.08/04/180QV2 SN OR BX	PCB plug-in connector, female plug, 5.08 mm, No. of poles: 4, 180°, Clamping yoke connection, Clamping range, max.: 4 mm ² , Box	4032248350292	100 pc(s).	Box
1839780000	BLZ 5.08/04/180QV2 SN BK BX	PCB plug-in connector, female plug, 5.08 mm, No. of poles: 4, 180°, Clamping yoke connection, Clamping range, max.: 4 mm ² , Box	4032248350308	100 pc(s).	Box

System pitch 5.08 mm (0.200 inch) SL-SMT 5.08/04/90G 3.2SN BK BX

Weidmüller Interface GmbH & Co. KG
 Klingenbergstraße 16
 D-32758 Detmold
 Germany
 Fon: +49 5231 14-0
 Fax: +49 5231 14-2083
 www.weidmueller.com

Counterpart

connection, Clamping range,
 max.: 4 mm², Box

BLL 5.08/90



Female connector for PCB mounting. The solder pin length is optimised for wave flow soldering. Packed in cardboard box.

- 400 V (IEC) / 300 V (UL)
- 23 A (IEC) / 15 A (UL)

General ordering data

Order No.	Part designation	Version	GTIN (EAN)	Qty.	Packaging
1622960000	BLL 5.08/04/90 3.2SN OR BX	PCB plug-in connector, female header, 5.08 mm, No. of poles: 4, 90°, Solder pin length: 3.2 mm, tinned, Orange, Solder connection, Box	4008190194024	100 pc(s).	Box

BLZ 5.08/225



Female connectors with clamping yoke screw connection for conductor connection with 225° outlet direction. The female connectors provide space for labelling and can be coded. Packed in cardboard box.

- 0.20 - 2.5 mm² (IEC) / 26 - 12 AWG (UL)
- 400 V (IEC) / 300 V (UL)
- 16.5 A (IEC) / 10 A (UL)

General ordering data

Order No.	Part designation	Version	GTIN (EAN)	Qty.	Packaging
1741890000	BLZ 5.08/04/225 SN BK BX	PCB plug-in connector, female plug, 5.08 mm, No. of poles: 4, 225°, Clamping yoke connection, Clamping range, max.: 3.31 mm ² , Box	4008190254155	90 pc(s).	Box
1741660000	BLZ 5.08/04/225 SN OR BX	PCB plug-in connector, female plug, 5.08 mm, No. of poles: 4, 225°, Clamping yoke connection, Clamping range, max.: 3.31 mm ² , Box	4008190202637	90 pc(s).	Box

**System pitch 5.08 mm (0.200 inch)
SL-SMT 5.08/04/90G 3.2SN BK BX**

Weidmüller Interface GmbH & Co. KG
Klingenbergstraße 16
D-32758 Detmold
Germany
Fon: +49 5231 14-0
Fax: +49 5231 14-2083
www.weidmueller.com

Counterpart
BLZ 5.08/270

Female connectors with clamping yoke screw connection. The female connectors provide space for labelling and can be coded. Packed in cardboard box.

- 0.20 - 2.5 mm² (IEC) / 26 - 12 AWG (UL)
- 400 V (IEC) / 300 V (UL)
- 15 A (IEC) / 10 A (UL)

General ordering data

Order No.	Part designation	Version	GTIN (EAN)	Qty.	Packaging
1557510000	BLZ 5.08/04/270 SN BK BX	PCB plug-in connector, female plug, 5.08 mm, No. of poles: 4, 270°, Clamping yoke connection, Clamping range, max.: 3.31 mm ² , Box	4008190269449	90 pc(s).	Box
1557560000	BLZ 5.08/04/270 SN OR BX	PCB plug-in connector, female plug, 5.08 mm, No. of poles: 4, 270°, Clamping yoke connection, Clamping range, max.: 3.31 mm ² , Box	4008190104788	90 pc(s).	Box

BLZF 5.08/270

Female connectors for connecting conductors with tension clamp system. The female connectors include space for labelling and can be coded. Packed in cardboard box.

- 0.20 - 2.5 mm² (IEC) / 26 - 12 AWG (UL)
- 400 V (IEC) / 300 V (UL)
- 16.5 A (IEC) / 10 A (UL)

General ordering data

Order No.	Part designation	Version	GTIN (EAN)	Qty.	Packaging
1671960000	BLZF 5.08/04/270 SN OR BX	PCB plug-in connector, female plug, 5.08 mm, No. of poles: 4, 270°, Tension clamp connection, Clamping range, max.: 3.31 mm ² , Box	4008190433673	90 pc(s).	Box
1672190000	BLZF 5.08/04/270 SN BK BX	PCB plug-in connector, female plug, 5.08 mm, No. of poles: 4, 270°, Tension clamp connection, Clamping range, max.: 3.31 mm ² , Box	4008190433901	90 pc(s).	Box

System pitch 5.08 mm (0.200 inch) SL-SMT 5.08/04/90G 3.2SN BK BX

Weidmüller Interface GmbH & Co. KG
 Klingenbergstraße 16
 D-32758 Detmold
 Germany
 Fon: +49 5231 14-0
 Fax: +49 5231 14-2083
 www.weidmueller.com

Counterpart

BLZP 5.08/270F SN



Socket connectors with clamping yoke screw connection for conductor connection with a right-angle (90° or 270°) outlet direction. The female connectors provide space for labelling and can be coded. Can be fastened with flange or release latch. They feature an integrated plus/minus screw, protection against false insertion under clamping yoke. They are delivered with an opened clamping yoke.

- 0.2-2.5 mm² (IEC) / 26-12 AWG (UL)
- 400 V (IEC) / 300 V (UL)
- 15 A (IEC) / 10 A (UL)

General ordering data

Order No.	Part designation	Version	GTIN (EAN)	Qty.	Packaging
1950570000	BLZP 5.08/04/270F SN BK BX	PCB plug-in connector, female plug, 5.08 mm, No. of poles: 4, 270°, Clamping yoke connection, Clamping range, max.: 4 mm ² , Box	4032248628704	60 pc(s).	Box
1950330000	BLZP 5.08/04/270F SN OR BX	PCB plug-in connector, female plug, 5.08 mm, No. of poles: 4, 270°, Clamping yoke connection, Clamping range, max.: 4 mm ² , Box	4032248628445	60 pc(s).	Box

BLZP 5.08/180F SN



Female connectors with clamping yoke screw connection for conductor connection with straight (180°) outlet direction. The female connectors provide space for labelling and can be coded. Can be fastened with flange or release latch. They feature an integrated plus/minus screw, protection against false insertion under clamping yoke. They are delivered with an opened clamping yoke.

- 0.2-2.5 mm² (IEC) / 26-12 AWG (UL)
- 400 V (IEC) / 300 V (UL)
- 19 A (IEC) / 15 A (UL)

General ordering data

Order No.	Part designation	Version	GTIN (EAN)	Qty.	Packaging
1944350000	BLZP 5.08/04/180F SN BK BX	PCB plug-in connector, female plug, 5.08 mm, No. of poles: 4, 180°, Clamping yoke connection, Clamping range, max.: 4 mm ² , Box	4032248618927	100 pc(s).	Box
1944110000	BLZP 5.08/04/180F SN OR BX	PCB plug-in connector, female plug, 5.08 mm, No. of poles: 4, 180°, Clamping yoke connection, Clamping range, max.: 4 mm ² , Box	4032248617494	100 pc(s).	Box

System pitch 5.08 mm (0.200 inch) SL-SMT 5.08/04/90G 3.2SN BK BX

Weidmüller Interface GmbH & Co. KG
 Klingenbergstraße 16
 D-32758 Detmold
 Germany
 Fon: +49 5231 14-0
 Fax: +49 5231 14-2083
 www.weidmueller.com

Counterpart

BLZP 5.00/270F SN

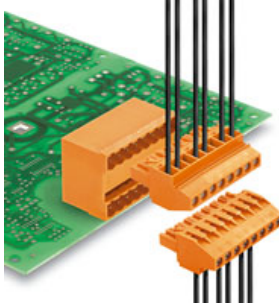

Socket connectors with clamping yoke screw connection for conductor connection with a right-angle (90° or 270°) outlet direction. The female connectors provide space for labelling and can be coded. Can be fastened with flange or release latch. They feature an integrated plus/minus screw, protection against false insertion under clamping yoke. They are delivered with an opened clamping yoke.

- 0.2-2.5 mm² (IEC) / 26-12 AWG (UL)
- 400 V (IEC) / 300 V (UL)
- 15 A (IEC) / 10 A (UL)

General ordering data

Order No.	Part designation	Version	GTIN (EAN)	Qty.	Packaging
1960710000	BLZP 5.00/04/270F SN BK BX	PCB plug-in connector, female plug, 5.00 mm, No. of poles: 4, 90°, Clamping yoke connection, Clamping range, max.: 4 mm ² , Box	4032248639502	60 pc(s).	Box
1960440000	BLZP 5.00/04/270F SN OR BX	PCB plug-in connector, female plug, 5.00 mm, No. of poles: 4, 90°, Clamping yoke connection, Clamping range, max.: 4 mm ² , Box	4032248639304	60 pc(s).	Box

BLZ 5.00/90B



Female connectors with clamping yoke screw connection. The female connectors provide space for labelling and can be coded. Packed in cardboard box.

- 0.20 - 2.5 mm² (IEC) / 26 - 12 AWG (UL)
- 400 V (IEC) / 300 V (UL)
- 15 A (IEC) / 10 A (UL)

General ordering data

Order No.	Part designation	Version	GTIN (EAN)	Qty.	Packaging
1637140000	BLZ 5.00/04/90B SN OR BX	PCB plug-in connector, female plug, 5.00 mm, No. of poles: 4, 90°, Clamping yoke connection, Clamping range, max.: 3.31 mm ² , Box	4008190274382	78 pc(s).	Box
1637370000	BLZ 5.00/04/90B SN BK BX	PCB plug-in connector, female plug, 5.00 mm, No. of poles: 4, 90°, Clamping yoke connection, Clamping range, max.: 3.31 mm ² , Box	4008190274610	78 pc(s).	Box

System pitch 5.08 mm (0.200 inch) SL-SMT 5.08/04/90G 3.2SN BK BX

Weidmüller Interface GmbH & Co. KG
 Klingenbergstraße 16
 D-32758 Detmold
 Germany
 Fon: +49 5231 14-0
 Fax: +49 5231 14-2083
 www.weidmueller.com

Counterpart

BLZ 5.08/180LH



Socket connectors with clamping yoke screw connection for conductor connection with 270° outlet direction and release lever or release latch mechanism. The female connectors provide space for labelling and can be coded. Packed in cardboard box.br/>

- 0.20–1.5 mm² (IEC) / 26–12 AWG (UL)
- 400 V (IEC) / 300 V (UL)
- 19 A (IEC) / 15 A (UL)

General ordering data

Order No.	Part designation	Version	GTIN (EAN)	Qty.	Packaging
1893620000	BLZ 5.08/04/180LH SN BK BX	PCB plug-in connector, female plug, 5.08 mm, No. of poles: 4, 180°, Clamping yoke connection, Clamping range, max.: 3.31 mm ² , Box	4032248507801	100 pc(s).	Box
1892210000	BLZ 5.08/04/180LH SN OR BX	PCB plug-in connector, female plug, 5.08 mm, No. of poles: 4, 180°, Clamping yoke connection, Clamping range, max.: 3.31 mm ² , Box	4032248505531	100 pc(s).	Box

BLZP 5.08/90F SN

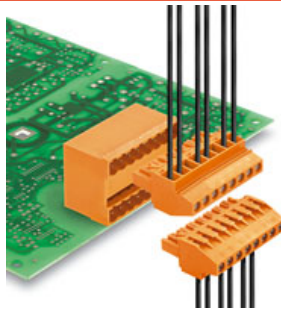

Socket connectors with clamping yoke screw connection for conductor connection with a right-angle (90° or 270°) outlet direction. The female connectors provide space for labelling and can be coded. Can be fastened with flange or release latch. They feature an integrated plus/minus screw, protection against false insertion under clamping yoke. They are delivered with an opened clamping yoke.

- 0.2-2.5 mm² (IEC) / 26-12 AWG (UL)
- 400 V (IEC) / 300 V (UL)
- 15 A (IEC) / 10 A (UL)

General ordering data

Order No.	Part designation	Version	GTIN (EAN)	Qty.	Packaging
1950060000	BLZP 5.08/04/90F SN BK BX	PCB plug-in connector, female plug, 5.08 mm, No. of poles: 4, 90°, Clamping yoke connection, Clamping range, max.: 4 mm ² , Box	4032248627998	60 pc(s).	Box
1949820000	BLZP 5.08/04/90F SN OR BX	PCB plug-in connector, female plug, 5.08 mm, No. of poles: 4, 90°, Clamping yoke connection, Clamping range, max.: 4 mm ² , Box	4032248627745	60 pc(s).	Box

System pitch 5.08 mm (0.200 inch) SL-SMT 5.08/04/90G 3.2SN BK BX

Weidmüller Interface GmbH & Co. KG
Klingenbergstraße 16
D-32758 Detmold
Germany
Fon: +49 5231 14-0
Fax: +49 5231 14-2083
www.weidmueller.com

Counterpart

BLZP 5.00/180F SN



Female connectors with clamping yoke screw connection for conductor connection with straight (180°) outlet direction. The female connectors provide space for labelling and can be coded. Can be fastened with flange or release latch. They feature an integrated plus/minus screw, protection against false insertion under clamping yoke. They are delivered with an opened clamping yoke.

- 0.2-2.5 mm² (IEC) / 26-12 AWG (UL)
- 400 V (IEC) / 300 V (UL)
- 19 A (IEC) / 15 A (UL)

General ordering data

Order No.	Part designation	Version	GTIN (EAN)	Qty.	Packaging
1956010000	BLZP 5.00/04/180F SN BK BX	PCB plug-in connector, female plug, 5.00 mm, No. of poles: 4, 180°, Clamping yoke connection, Clamping range, max.: 4 mm ² , Box	4032248634583	100 pc(s).	Box
1955780000	BLZP 5.00/04/180F SN OR BX	PCB plug-in connector, female plug, 5.00 mm, No. of poles: 4, 180°, Clamping yoke connection, Clamping range, max.: 4 mm ² , Box	4032248634323	100 pc(s).	Box

BLZP 5.00/270LH SN



Socket connectors with clamping yoke screw connection for conductor connection with a right-angle (90° or 270°) outlet direction. The female connectors provide space for labelling and can be coded. Can be fastened with flange or release latch. They feature an integrated plus/minus screw, protection against false insertion under clamping yoke. They are delivered with an opened clamping yoke.

- 0.2-2.5 mm² (IEC) / 26-12 AWG (UL)
- 400 V (IEC) / 300 V (UL)
- 15 A (IEC) / 10 A (UL)

General ordering data

Order No.	Part designation	Version	GTIN (EAN)	Qty.	Packaging
1961650000	BLZP 5.00/04/270LH SN BK BX	PCB plug-in connector, female plug, 5.00 mm, No. of poles: 4, 90°, Clamping yoke connection, Clamping range, max.: 4 mm ² , Box	4032248640928	60 pc(s).	Box
1961420000	BLZP 5.00/04/270LH SN OR BX	PCB plug-in connector, female plug, 5.00 mm, No. of poles: 4, 90°, Clamping yoke connection, Clamping range, max.: 4 mm ² , Box	4032248640690	60 pc(s).	Box

System pitch 5.08 mm (0.200 inch) SL-SMT 5.08/04/90G 3.2SN BK BX

Weidmüller Interface GmbH & Co. KG
 Klingenbergstraße 16
 D-32758 Detmold
 Germany
 Fon: +49 5231 14-0
 Fax: +49 5231 14-2083
 www.weidmueller.com

Counterpart

BLZ 5.08/180F



Female connectors with clamping yoke screw connection for conductor connection with straight outlet direction. The female connectors provide space for labelling and can be coded. Packed in cardboard box.

- 0.20 - 2.5 mm² (IEC) / 26 - 12 AWG (UL)
- 400 V (IEC) / 300 V (UL)
- 19 A (IEC) / 15 A (UL)

General ordering data

Order No.	Part designation	Version	GTIN (EAN)	Qty.	Packaging
1803060000	BLZ 5.08/04/180F SN BK BX	PCB plug-in connector, female plug, 5.08 mm, No. of poles: 4, 180°, Clamping yoke connection, Clamping range, max.: 3.31 mm ² , Box	4032248258161	100 pc(s).	Box
1802850000	BLZ 5.08/04/180F SN OR BX	PCB plug-in connector, female plug, 5.08 mm, No. of poles: 4, 180°, Clamping yoke connection, Clamping range, max.: 3.31 mm ² , Box	4032248257928	100 pc(s).	Box

BLT 5.08F

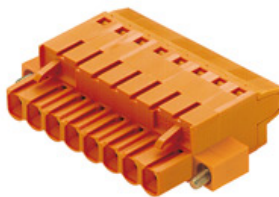

Female connectors with TOP screw system for connecting conductors with straight 180° outlet direction. The female connectors include space for labelling and can be coded. Packed in cardboard box.

- 0.20 - 2.5 mm² (IEC) / 26 - 14 AWG (UL)
- 400 V (IEC) / 300 V (UL)
- 17 A (IEC) / 10 A (UL)

General ordering data

Order No.	Part designation	Version	GTIN (EAN)	Qty.	Packaging
1844240000	BLT 5.08/04/180F SN BK BX	PCB plug-in connector, female plug, 5.08 mm, No. of poles: 4, 180°, TOP connection, Clamping range, max.: 2.5 mm ² , Box	4032248356171	60 pc(s).	Box
1844010000	BLT 5.08/04/180F SN OR BX	PCB plug-in connector, female plug, 5.08 mm, No. of poles: 4, 180°, TOP connection, Clamping range, max.: 2.5 mm ² , Box	4032248355938	60 pc(s).	Box

System pitch 5.08 mm (0.200 inch) SL-SMT 5.08/04/90G 3.2SN BK BX

Weidmüller Interface GmbH & Co. KG
Klingenbergstraße 16
D-32758 Detmold
Germany
Fon: +49 5231 14-0
Fax: +49 5231 14-2083
www.weidmueller.com

Counterpart

BLL 5.08/90FI



Female connector for PCB mounting. The solder pin length is optimised for wave flow soldering. Packed in cardboard box.

- 400 V (IEC) / 300 V (UL)
- 23 A (IEC) / 15 A (UL)

General ordering data

Order No.	Part designation	Version	GTIN (EAN)	Qty.	Packaging
1843770000	BLL 5.08/04/90FI 3.2SN OR BX	PCB plug-in connector, female header, 5.08 mm, No. of poles: 4, 90°, Solder pin length: 3.2 mm, tinned, Orange, Solder connection, Box	4032248355525	100 pc(s).	Box

BLF 5.08/90LH SN



Just as reliable as the tried-and-true original, with innovation in detail:

The BLF 5.0x – the PUSH-IN version of the BLZ 5.0x socket block – features a new connection system and a more compact design. Weidmüller's innovative PUSH-IN spring connection features a trend-setting, tool-free wire connection system that is simple to operate.

In terms of versatility, the BLF 5.0x offers just as much as the older versions:

- The choice of three wire outlet directions offers you proven design flexibility for your applications.
- Four flange variations, including the patented release latch, allow for user-friendly unplugging designs.

General ordering data

Order No.	Part designation	Version	GTIN (EAN)	Qty.	Packaging
1000660001	BLF 5.08/04/90LH SN BK BX	PCB plug-in connector, female plug, 5.08 mm, No. of poles: 4, 90°, PUSH IN, Clamping range, max.: 3.31 mm², Box	4032248690855	60 pc(s).	Box
1002500000	BLF 5.08/04/90LH SN OR BX	PCB plug-in connector, female plug, 5.08 mm, No. of poles: 4, 90°, PUSH IN, Clamping range, max.: 3.31 mm², Box	4032248694877	60 pc(s).	Box

System pitch 5.08 mm (0.200 inch) SL-SMT 5.08/04/90G 3.2SN BK BX

Weidmüller Interface GmbH & Co. KG
 Klingenbergstraße 16
 D-32758 Detmold
 Germany
 Fon: +49 5231 14-0
 Fax: +49 5231 14-2083
 www.weidmueller.com

Counterpart

BLZP 5.00/180LR SN



Female connectors with clamping yoke screw connection for conductor connection with straight (180°) outlet direction. The female connectors provide space for labelling and can be coded. Can be fastened with flange or release latch. They feature an integrated plus/minus screw, protection against false insertion under clamping yoke. They are delivered with an opened clamping yoke.

- 0.2-2.5 mm² (IEC) / 26-12 AWG (UL)
- 400 V (IEC) / 300 V (UL)
- 19 A (IEC) / 15 A (UL)

General ordering data

Order No.	Part designation	Version	GTIN (EAN)	Qty.	Packaging
1956350000	BLZP 5.00/04/180LR SN OR BX	PCB plug-in connector, female plug, 5.00 mm, No. of poles: 4, 180°, Clamping yoke connection, Clamping range, max.: 4 mm ² , Box	4032248635054	100 pc(s).	Box
1956580000	BLZP 5.00/04/180LR SN BK BX	PCB plug-in connector, female plug, 5.00 mm, No. of poles: 4, 180°, Clamping yoke connection, Clamping range, max.: 4 mm ² , Box	4032248635405	100 pc(s).	Box

BLDT 5.08B



Female connectors with two clamping yoke screw connections per pole for conductor connection with 90° & 270° outlet direction. The female connectors provide space for labelling and can be coded. Packed in cardboard box.

- 0.20 - 2.5 mm² (IEC) / 26 - 12 AWG (UL)
- 400 V (IEC) / 300 V (UL)
- 14 A (IEC) / 10 A (UL)

General ordering data

Order No.	Part designation	Version	GTIN (EAN)	Qty.	Packaging
1651760000	BLDT 5.08/04/-B SN OR BX	PCB plug-in connector, female plug, 5.08 mm, No. of poles: 4, 90°/270°, Clamping yoke connection, Clamping range, max.: 3.31 mm ² , Box	4008190400446	50 pc(s).	Box
1673800000	BLDT 5.08/04/-B SN BK BX	PCB plug-in connector, female plug, 5.08 mm, No. of poles: 4, 90°/270°, Clamping yoke connection, Clamping range, max.: 3.31 mm ² , Box	4008190435530	50 pc(s).	Box

System pitch 5.08 mm (0.200 inch) SL-SMT 5.08/04/90G 3.2SN BK BX

Weidmüller Interface GmbH & Co. KG
 Klingenbergstraße 16
 D-32758 Detmold
 Germany
 Fon: +49 5231 14-0
 Fax: +49 5231 14-2083
 www.weidmueller.com

Counterpart

BLZ 5.00/180F



Female connectors with clamping yoke screw connection for conductor connection with straight outlet direction. The female connectors provide space for labelling and can be coded. Packed in cardboard box.

- 0.20 - 2.5 mm² (IEC) / 26 - 12 AWG (UL)
- 400 V (IEC) / 300 V (UL)
- 19 A (IEC) / 15 A (UL)

General ordering data

Order No.	Part designation	Version	GTIN (EAN)	Qty.	Packaging
1843310000	BLZ 5.00/04/180F SN OR BX	PCB plug-in connector, female plug, 5.00 mm, No. of poles: 4, 180°, Clamping yoke connection, Clamping range, max.: 3.31 mm ² , Box	4032248355037	100 pc(s).	Box
1843540000	BLZ 5.00/04/180F SN BK BX	PCB plug-in connector, female plug, 5.00 mm, No. of poles: 4, 180°, Clamping yoke connection, Clamping range, max.: 3.31 mm ² , Box	4032248355266	100 pc(s).	Box

BLZP 5.08/180LH SN



Female connectors with clamping yoke screw connection for conductor connection with straight (180°) outlet direction. The female connectors provide space for labelling and can be coded. Can be fastened with flange or release latch. They feature an integrated plus/minus screw, protection against false insertion under clamping yoke. They are delivered with an opened clamping yoke.

- 0.2-2.5 mm² (IEC) / 26-12 AWG (UL)
- 400 V (IEC) / 300 V (UL)
- 19 A (IEC) / 15 A (UL)

General ordering data

Order No.	Part designation	Version	GTIN (EAN)	Qty.	Packaging
1945540000	BLZP 5.08/04/180LH SN BK BX	PCB plug-in connector, female plug, 5.08 mm, No. of poles: 4, 180°, Clamping yoke connection, Clamping range, max.: 4 mm ² , Box	4032248620715	100 pc(s).	Box
1945310000	BLZP 5.08/04/180LH SN OR BX	PCB plug-in connector, female plug, 5.08 mm, No. of poles: 4, 180°, Clamping yoke connection, Clamping range, max.: 4 mm ² , Box	4032248619887	100 pc(s).	Box

System pitch 5.08 mm (0.200 inch) SL-SMT 5.08/04/90G 3.2SN BK BX

Weidmüller Interface GmbH & Co. KG
 Klingenbergstraße 16
 D-32758 Detmold
 Germany
 Fon: +49 5231 14-0
 Fax: +49 5231 14-2083
 www.weidmueller.com

Counterpart

BLZ 5.08/90B

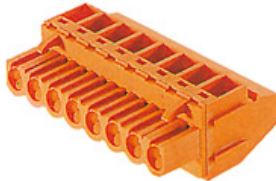

Female connectors with clamping yoke screw connection. The female connectors provide space for labelling and can be coded. Packed in cardboard box.

- 0.20 - 2.5 mm² (IEC) / 26 - 12 AWG (UL)
- 400 V (IEC) / 300 V (UL)
- 15 A (IEC) / 10 A (UL)

General ordering data

Order No.	Part designation	Version	GTIN (EAN)	Qty.	Packaging
1555260000	BLZ 5.08/04/90B SN OR BX	PCB plug-in connector, female plug, 5.08 mm, No. of poles: 4, 90°, Clamping yoke connection, Clamping range, max.: 3.31 mm ² , Box	4008190169589	78 pc(s).	Box
1555210000	BLZ 5.08/04/90B SN BK BX	PCB plug-in connector, female plug, 5.08 mm, No. of poles: 4, 90°, Clamping yoke connection, Clamping range, max.: 3.31 mm ² , Box	4008190267964	78 pc(s).	Box

BLC 5.08BR

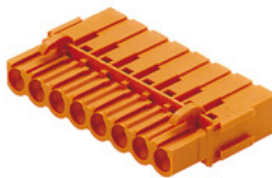

Female connectors for conductor connection with crimp connection system. The female connectors provide space for labelling and can be coded. Packed in cardboard box.

- 0.25 - 2.5 mm² (IEC) / 26 - 14 AWG (UL)
- 400 V (IEC) / 300 V (UL)
- 21 A (IEC) / 10 A (UL)

General ordering data

Order No.	Part designation	Version	GTIN (EAN)	Qty.	Packaging
1649390000	BLC 5.08/04/180BR OR BX	PCB plug-in connector, female plug, 5.08 mm, No. of poles: 4, 180°, Crimp connection, Clamping range, max.: 2.5 mm ² , Box	4008190294502	100 pc(s).	Box
1712130000	BLC 5.08/04/180BR BK BX	PCB plug-in connector, female plug, 5.08 mm, No. of poles: 4, 180°, Crimp connection, Clamping range, max.: 2.5 mm ² , Box	4008190935146	100 pc(s).	Box

System pitch 5.08 mm (0.200 inch) SL-SMT 5.08/04/90G 3.2SN BK BX

Weidmüller Interface GmbH & Co. KG
Klingenbergstraße 16
D-32758 Detmold
Germany
Fon: +49 5231 14-0
Fax: +49 5231 14-2083
www.weidmueller.com

Counterpart

BLF 5.08/90LR SN



Just as reliable as the tried-and-true original, with innovation in detail:

The BLF 5.0x – the PUSH-IN version of the BLZ 5.0x socket block – features a new connection system and a more compact design. Weidmüller's innovative PUSH-IN spring connection features a trend-setting, tool-free wire connection system that is simple to operate.

In terms of versatility, the BLF 5.0x offers just as much as the older versions:

- The choice of three wire outlet directions offers you proven design flexibility for your applications.
- Four flange variations, including the patented release latch, allow for user-friendly unplugging designs.

General ordering data

Order No.	Part designation	Version	GTIN (EAN)	Qty.	Packaging
1000430001	BLF 5.08/04/90LR SN BK BX	PCB plug-in connector, female plug, 5.08 mm, No. of poles: 4, 90°, PUSH IN, Clamping range, max.: 3.31 mm², Box	4032248690398	60 pc(s).	Box
1002300000	BLF 5.08/04/90LR SN OR BX	PCB plug-in connector, female plug, 5.08 mm, No. of poles: 4, 90°, PUSH IN, Clamping range, max.: 3.31 mm², Box	4032248694464	60 pc(s).	Box

BLZP 5.08/270LR SN



Socket connectors with clamping yoke screw connection for conductor connection with a right-angle (90° or 270°) outlet direction. The female connectors provide space for labelling and can be coded. Can be fastened with flange or release latch. They feature an integrated plus/minus screw, protection against false insertion under clamping yoke. They are delivered with an opened clamping yoke.

- 0.2-2.5 mm² (IEC) / 26-12 AWG (UL)
- 400 V (IEC) / 300 V (UL)
- 15 A (IEC) / 10 A (UL)

General ordering data

Order No.	Part designation	Version	GTIN (EAN)	Qty.	Packaging
1947550000	BLZP 5.08/04/270LR SN OR BX	PCB plug-in connector, female plug, 5.08 mm, No. of poles: 4, 270°, Clamping yoke connection, Clamping range, max.: 4 mm², Box	4032248623846	60 pc(s).	Box
1947780000	BLZP 5.08/04/270LR SN BK BX	PCB plug-in connector, female plug, 5.08 mm, No. of poles: 4, 270°, Clamping yoke connection, Clamping range, max.: 4 mm², Box	4032248624171	60 pc(s).	Box

System pitch 5.08 mm (0.200 inch) SL-SMT 5.08/04/90G 3.2SN BK BX

Weidmüller Interface GmbH & Co. KG
 Klingenbergstraße 16
 D-32758 Detmold
 Germany
 Fon: +49 5231 14-0
 Fax: +49 5231 14-2083
 www.weidmueller.com

Counterpart

BLL 5.08/180B



Female connector for PCB mounting. The solder pin length is optimised for wave flow soldering. Packed in cardboard box.

- 400 V (IEC) / 300 V (UL)
- 23 A (IEC) / 15 A (UL)

General ordering data

Order No.	Part designation	Version	GTIN (EAN)	Qty.	Packaging
1682750000	BLL 5.08/04/180B 3.2SN OR BX	PCB plug-in connector, female header, 5.08 mm, No. of poles: 4, 180°, Solder pin length: 3.2 mm, tinned, Orange, Solder connection, Box	4008190474515	100 pc(s).	Box

BLZ 5.00/270B



Female connectors with clamping yoke screw connection. The female connectors provide space for labelling and can be coded. Packed in cardboard box.

- 0.20 - 2.5 mm² (IEC) / 26 - 12 AWG (UL)
- 400 V (IEC) / 300 V (UL)
- 15 A (IEC) / 10 A (UL)

General ordering data

Order No.	Part designation	Version	GTIN (EAN)	Qty.	Packaging
1638290000	BLZ 5.00/04/270B SN BK BX	PCB plug-in connector, female plug, 5.00 mm, No. of poles: 4, 270°, Clamping yoke connection, Clamping range, max.: 3.31 mm ² , Box	4008190275556	78 pc(s).	Box
1638060000	BLZ 5.00/04/270B SN OR BX	PCB plug-in connector, female plug, 5.00 mm, No. of poles: 4, 270°, Clamping yoke connection, Clamping range, max.: 3.31 mm ² , Box	4008190275327	78 pc(s).	Box

System pitch 5.08 mm (0.200 inch) SL-SMT 5.08/04/90G 3.2SN BK BX

Weidmüller Interface GmbH & Co. KG
Klingenbergstraße 16
D-32758 Detmold
Germany
Fon: +49 5231 14-0
Fax: +49 5231 14-2083
www.weidmueller.com

Counterpart

BLZF 5.08/180LH



Socket blocks for conductor connection, featuring the time-saving tension clamp technology, with straight outlet direction and release lever or release latch mechanism. The female connectors provide space for labelling and can be coded. Packed in cardboard box.

- 0.20 - 1.5 mm² (IEC) / 26 - 12 AWG (UL)
- 400 V (IEC) / 300 V (UL)
- 17 A (IEC) / 15 A (UL)

General ordering data

Order No.	Part designation	Version	GTIN (EAN)	Qty.	Packaging
1893180000	BLZF 5.08/04/180LH SN BK BX	PCB plug-in connector, female plug, 5.08 mm, No. of poles: 4, 180°, Tension clamp connection, Clamping range, max.: 3.31 mm ² , Box	4032248507320	60 pc(s).	Box
1895740000	BLZF 5.08/04/180LH SN OR BX	PCB plug-in connector, female plug, 5.08 mm, No. of poles: 4, 180°, Tension clamp connection, Clamping range, max.: 3.31 mm ² , Box	4032248510467	60 pc(s).	Box

BLZF 5.08/180F



Female connectors for connecting conductors with tension clamp system, straight 180° outlet direction. The female connectors include space for labelling and can be coded. Packed in cardboard box.

- 0.20 - 2.5 mm² (IEC) / 26 - 12 AWG (UL)
- 400 V (IEC) / 300 V (UL)
- 17 A (IEC) / 15 A (UL)

General ordering data

Order No.	Part designation	Version	GTIN (EAN)	Qty.	Packaging
1803580000	BLZF 5.08/04/180F SN BK BX	PCB plug-in connector, female plug, 5.08 mm, No. of poles: 4, 180°, Tension clamp connection, Clamping range, max.: 3.31 mm ² , Box	4032248258987	60 pc(s).	Box
1803350000	BLZF 5.08/04/180F SN OR BX	PCB plug-in connector, female plug, 5.08 mm, No. of poles: 4, 180°, Tension clamp connection, Clamping range, max.: 3.31 mm ² , Box	4032248258758	60 pc(s).	Box

System pitch 5.08 mm (0.200 inch) SL-SMT 5.08/04/90G 3.2SN BK BX

Weidmüller Interface GmbH & Co. KG
 Klingenbergstraße 16
 D-32758 Detmold
 Germany
 Fon: +49 5231 14-0
 Fax: +49 5231 14-2083
 www.weidmueller.com

Counterpart

BLT 5.08LR



Socket connectors with clamping yoke screw connection for conductor connection with 270° outlet direction and release lever or release latch mechanism. The female connectors provide space for labelling and can be coded. Packed in cardboard box.

- 0.20 - 1.5 mm² (IEC) / 26 - 14 AWG (UL)
- 400 V (IEC) / 300 V (UL)
- 17 A (IEC) / 10 A (UL)

General ordering data

Order No.	Part designation	Version	GTIN (EAN)	Qty.	Packaging
1894150000	BLT 5.08/04/180LR SN BK BX	PCB plug-in connector, female plug, 5.08 mm, No. of poles: 4, 180°, TOP connection, Clamping range, max.: 2.5 mm ² , Box	4032248508396	60 pc(s).	Box
1890240000	BLT 5.08/04/180LR SN OR BX	PCB plug-in connector, female plug, 5.08 mm, No. of poles: 4, 180°, TOP connection, Clamping range, max.: 2.5 mm ² , Box	4032248498727	60 pc(s).	Box

BLF 5.00/90LH SN



Just as reliable as the tried-and-true original, with innovation in detail:

The BLF 5.0x – the PUSH-IN version of the BLZ 5.0x socket block – features a new connection system and a more compact design. Weidmüller's innovative PUSH-IN spring connection features a trend-setting, tool-free wire connection system that is simple to operate.

In terms of versatility, the BLF 5.0x offers just as much as the older versions:

- The choice of three wire outlet directions offers you proven design flexibility for your applications.
- Four flange variations, including the patented release latch, allow for user-friendly unplugging designs.

General ordering data

Order No.	Part designation	Version	GTIN (EAN)	Qty.	Packaging
1981390000	BLF 5.00/04/90LH SN OR BX	PCB plug-in connector, female plug, 5.00 mm, No. of poles: 4, 90°, PUSH IN, Clamping range, max.: 3.31 mm ² , Box	4032248676699	60 pc(s).	Box
1980000000	BLF 5.00/04/90LH SN BK BX	PCB plug-in connector, female plug, 5.00 mm, No. of poles: 4, 90°, PUSH IN, Clamping range, max.: 3.31 mm ² , Box	4032248675067	60 pc(s).	Box

System pitch 5.08 mm (0.200 inch) SL-SMT 5.08/04/90G 3.2SN BK BX

Weidmüller Interface GmbH & Co. KG
Klingenbergstraße 16
D-32758 Detmold
Germany
Fon: +49 5231 14-0
Fax: +49 5231 14-2083
www.weidmueller.com

Counterpart

BLZ 5.08/180LR



Socket connectors with clamping yoke screw connection for conductor connection with 270° outlet direction and release lever or release latch mechanism. The female connectors provide space for labelling and can be coded. Packed in cardboard box.

- 0.20 - 1.5 mm² (IEC) / 26 - 12 AWG (UL)
- 400 V (IEC) / 300 V (UL)
- 19 A (IEC) / 15 A (UL)

General ordering data

Order No.	Part designation	Version	GTIN (EAN)	Qty.	Packaging
1851220000	BLZ 5.08/04/180LR SN OR BX	PCB plug-in connector, female plug, 5.08 mm, No. of poles: 4, 180°, Clamping yoke connection, Clamping range, max.: 3.31 mm ² , Box	4032248381296	100 pc(s).	Box
1892970000	BLZ 5.08/04/180LR SN BK BX	PCB plug-in connector, female plug, 5.08 mm, No. of poles: 4, 180°, Clamping yoke connection, Clamping range, max.: 3.31 mm ² , Box	4032248507115	100 pc(s).	Box

BLZP 5.00/270LR SN



Socket connectors with clamping yoke screw connection for conductor connection with a right-angle (90° or 270°) outlet direction. The female connectors provide space for labelling and can be coded. Can be fastened with flange or release latch. They feature an integrated plus/minus screw, protection against false insertion under clamping yoke. They are delivered with an opened clamping yoke.

- 0.2-2.5 mm² (IEC) / 26-12 AWG (UL)
- 400 V (IEC) / 300 V (UL)
- 15 A (IEC) / 10 A (UL)

General ordering data

Order No.	Part designation	Version	GTIN (EAN)	Qty.	Packaging
1960940000	BLZP 5.00/04/270LR SN OR BX	PCB plug-in connector, female plug, 5.00 mm, No. of poles: 4, 90°, Clamping yoke connection, Clamping range, max.: 4 mm ² , Box	4032248639977	60 pc(s).	Box
1961170000	BLZP 5.00/04/270LR SN BK BX	PCB plug-in connector, female plug, 5.00 mm, No. of poles: 4, 90°, Clamping yoke connection, Clamping range, max.: 4 mm ² , Box	4032248640256	60 pc(s).	Box

System pitch 5.08 mm (0.200 inch) SL-SMT 5.08/04/90G 3.2SN BK BX

Weidmüller Interface GmbH & Co. KG
Klingenbergstraße 16
D-32758 Detmold
Germany
Fon: +49 5231 14-0
Fax: +49 5231 14-2083
www.weidmueller.com

Counterpart

BLZF 5.08/90B



Female connectors for connecting conductors with tension clamp system. The female connectors include space for labelling and can be coded. Packed in cardboard box.

- 0.20 - 2.5 mm² (IEC) / 26 - 12 AWG (UL)
- 400 V (IEC) / 300 V (UL)
- 16.5 A (IEC) / 10 A (UL)

General ordering data

Order No.	Part designation	Version	GTIN (EAN)	Qty.	Packaging
1671500000	BLZF 5.08/04/90B SN BK BX	PCB plug-in connector, female plug, 5.08 mm, No. of poles: 4, 90°, Tension clamp connection, Clamping range, max.: 3.31 mm ² , Box	4008190433208	78 pc(s).	Box
1671270000	BLZF 5.08/04/90B SN OR BX	PCB plug-in connector, female plug, 5.08 mm, No. of poles: 4, 90°, Tension clamp connection, Clamping range, max.: 3.31 mm ² , Box	4008190432973	78 pc(s).	Box

BLF 5.00/90F SN



Just as reliable as the tried-and-true original, with innovation in detail:

The BLF 5.0x – the PUSH-IN version of the BLZ 5.0x socket block – features a new connection system and a more compact design. Weidmüller's innovative PUSH-IN spring connection features a trend-setting, tool-free wire connection system that is simple to operate.

In terms of versatility, the BLF 5.0x offers just as much as the older versions:

- The choice of three wire outlet directions offers you proven design flexibility for your applications.
- Four flange variations, including the patented release latch, allow for user-friendly unplugging designs.

General ordering data

Order No.	Part designation	Version	GTIN (EAN)	Qty.	Packaging
1979480000	BLF 5.00/04/90F SN BK BX	PCB plug-in connector, female plug, 5.00 mm, No. of poles: 4, 90°, PUSH IN, Clamping range, max.: 3.31 mm ² , Box	4032248674688	60 pc(s).	Box
1980660000	BLF 5.00/04/90F SN OR BX	PCB plug-in connector, female plug, 5.00 mm, No. of poles: 4, 90°, PUSH IN, Clamping range, max.: 3.31 mm ² , Box	4032248675814	60 pc(s).	Box

System pitch 5.08 mm (0.200 inch) SL-SMT 5.08/04/90G 3.2SN BK BX

Weidmüller Interface GmbH & Co. KG
 Klingenbergstraße 16
 D-32758 Detmold
 Germany
 Fon: +49 5231 14-0
 Fax: +49 5231 14-2083
 www.weidmueller.com

Counterpart

BLF 5.00/90LR SN



Just as reliable as the tried-and-true original, with innovation in detail:

The BLF 5.0x – the PUSH-IN version of the BLZ 5.0x socket block – features a new connection system and a more compact design. Weidmüller's innovative PUSH-IN spring connection features a trend-setting, tool-free wire connection system that is simple to operate.

In terms of versatility, the BLF 5.0x offers just as much as the older versions:

- The choice of three wire outlet directions offers you proven design flexibility for your applications.
- Four flange variations, including the patented release latch, allow for user-friendly unplugging designs.

General ordering data

Order No.	Part designation	Version	GTIN (EAN)	Qty.	Packaging
1979810000	BLF 5.00/04/90LR SN BK BX	PCB plug-in connector, female plug, 5.00 mm, No. of poles: 4, 90°, PUSH IN, Clamping range, max.: 3.31 mm², Box	4032248674077	60 pc(s).	Box
1980890000	BLF 5.00/04/90LR SN OR BX	PCB plug-in connector, female plug, 5.00 mm, No. of poles: 4, 90°, PUSH IN, Clamping range, max.: 3.31 mm², Box	4032248676002	60 pc(s).	Box

BLT 5.08LH



Female connectors with TOP screw system for connecting conductors with straight 180° outlet direction. The female connectors include space for labelling and can be coded. Packed in cardboard box.

- 0.20 - 2.5 mm² (IEC) / 26 - 14 AWG (UL)
- 400 V (IEC) / 300 V (UL)
- 17 A (IEC) / 10 A (UL)

General ordering data

Order No.	Part designation	Version	GTIN (EAN)	Qty.	Packaging
1892510000	BLT 5.08/04/180LH SN BK BX	PCB plug-in connector, female plug, 5.08 mm, No. of poles: 4, 180°, TOP connection, Clamping range, max.: 2.5 mm², Box	4032248506552	60 pc(s).	Box
1889980000	BLT 5.08/04/180LH SN OR BX	PCB plug-in connector, female plug, 5.08 mm, No. of poles: 4, 180°, TOP connection, Clamping range, max.: 2.5 mm², Box	4032248498420	60 pc(s).	Box

System pitch 5.08 mm (0.200 inch) SL-SMT 5.08/04/90G 3.2SN BK BX

Weidmüller Interface GmbH & Co. KG
 Klingenbergstraße 16
 D-32758 Detmold
 Germany
 Fon: +49 5231 14-0
 Fax: +49 5231 14-2083
 www.weidmueller.com

Counterpart

BLZP 5.00/90F SN



Socket connectors with clamping yoke screw connection for conductor connection with a right-angle (90° or 270°) outlet direction. The female connectors provide space for labelling and can be coded. Can be fastened with flange or release latch. They feature an integrated plus/minus screw, protection against false insertion under clamping yoke. They are delivered with an opened clamping yoke.

- 0.2-2.5 mm² (IEC) / 26-12 AWG (UL)
- 400 V (IEC) / 300 V (UL)
- 15 A (IEC) / 10 A (UL)

General ordering data

Order No.	Part designation	Version	GTIN (EAN)	Qty.	Packaging
1959730000	BLZP 5.00/04/90F SN BK BX	PCB plug-in connector, female plug, 5.00 mm, No. of poles: 4, 90°, Clamping yoke connection, Clamping range, max.: 4 mm ² , Box	4032248638666	60 pc(s).	Box
1959500000	BLZP 5.00/04/90F SN OR BX	PCB plug-in connector, female plug, 5.00 mm, No. of poles: 4, 90°, Clamping yoke connection, Clamping range, max.: 4 mm ² , Box	4032248638437	60 pc(s).	Box

BLZ 5.08/225B



Female connectors with clamping yoke screw connection for conductor connection with 225° outlet direction. The female connectors provide space for labelling and can be coded. Packed in cardboard box.

- 0.20 - 2.5 mm² (IEC) / 26 - 12 AWG (UL)
- 400 V (IEC) / 300 V (UL)
- 16.5 A (IEC) / 10 A (UL)

General ordering data

Order No.	Part designation	Version	GTIN (EAN)	Qty.	Packaging
1742350000	BLZ 5.08/04/225B SN BK BX	PCB plug-in connector, female plug, 5.08 mm, No. of poles: 4, 225°, Clamping yoke connection, Clamping range, max.: 3.31 mm ² , Box	4032248049783	78 pc(s).	Box
1742120000	BLZ 5.08/04/225B SN OR BX	PCB plug-in connector, female plug, 5.08 mm, No. of poles: 4, 225°, Clamping yoke connection, Clamping range, max.: 3.31 mm ² , Box	4008190246440	78 pc(s).	Box

System pitch 5.08 mm (0.200 inch) SL-SMT 5.08/04/90G 3.2SN BK BX

Weidmüller Interface GmbH & Co. KG
 Klingenbergstraße 16
 D-32758 Detmold
 Germany
 Fon: +49 5231 14-0
 Fax: +49 5231 14-2083
 www.weidmueller.com

Counterpart

BLZ 5.08/270B



Female connectors with clamping yoke screw connection. The female connectors provide space for labelling and can be coded. Packed in cardboard box.

- 0.20 - 2.5 mm² (IEC) / 26 - 12 AWG (UL)
- 400 V (IEC) / 300 V (UL)
- 15 A (IEC) / 10 A (UL)

General ordering data

Order No.	Part designation	Version	GTIN (EAN)	Qty.	Packaging
1559860000	BLZ 5.08/04/270B SN OR BX	PCB plug-in connector, female plug, 5.08 mm, No. of poles: 4, 270°, Clamping yoke connection, Clamping range, max.: 3.31 mm ² , Box	4008190044305	78 pc(s).	Box
1559810000	BLZ 5.08/04/270B SN BK BX	PCB plug-in connector, female plug, 5.08 mm, No. of poles: 4, 270°, Clamping yoke connection, Clamping range, max.: 3.31 mm ² , Box	4008190269678	78 pc(s).	Box

BLZP 5.00/180LH SN



Female connectors with clamping yoke screw connection for conductor connection with straight (180°) outlet direction. The female connectors provide space for labelling and can be coded. Can be fastened with flange or release latch. They feature an integrated plus/minus screw, protection against false insertion under clamping yoke. They are delivered with an opened clamping yoke.

- 0.2-2.5 mm² (IEC) / 26-12 AWG (UL)
- 400 V (IEC) / 300 V (UL)
- 19 A (IEC) / 15 A (UL)

General ordering data

Order No.	Part designation	Version	GTIN (EAN)	Qty.	Packaging
1956970000	BLZP 5.00/04/180LH SN OR BX	PCB plug-in connector, female plug, 5.00 mm, No. of poles: 4, 180°, Clamping yoke connection, Clamping range, max.: 4 mm ² , Box	4032248635856	100 pc(s).	Box
1957270000	BLZP 5.00/04/180LH SN BK BX	PCB plug-in connector, female plug, 5.00 mm, No. of poles: 4, 180°, Clamping yoke connection, Clamping range, max.: 4 mm ² , Box	4032248636082	100 pc(s).	Box

System pitch 5.08 mm (0.200 inch) SL-SMT 5.08/04/90G 3.2SN BK BX

Weidmüller Interface GmbH & Co. KG
 Klingenbergstraße 16
 D-32758 Detmold
 Germany
 Fon: +49 5231 14-0
 Fax: +49 5231 14-2083
 www.weidmueller.com

Counterpart

BLZP 5.08/270LH SN



Socket connectors with clamping yoke screw connection for conductor connection with a right-angle (90° or 270°) outlet direction. The female connectors provide space for labelling and can be coded. Can be fastened with flange or release latch. They feature an integrated plus/minus screw, protection against false insertion under clamping yoke. They are delivered with an opened clamping yoke.

- 0.2-2.5 mm² (IEC) / 26-12 AWG (UL)
- 400 V (IEC) / 300 V (UL)
- 15 A (IEC) / 10 A (UL)

General ordering data

Order No.	Part designation	Version	GTIN (EAN)	Qty.	Packaging
1947260000	BLZP 5.08/04/270LH SN BK BX	PCB plug-in connector, female plug, 5.08 mm, No. of poles: 4, 270°, Clamping yoke connection, Clamping range, max.: 4 mm ² , Box	4032248623211	60 pc(s).	Box
1947030000	BLZP 5.08/04/270LH SN OR BX	PCB plug-in connector, female plug, 5.08 mm, No. of poles: 4, 270°, Clamping yoke connection, Clamping range, max.: 4 mm ² , Box	4032248622795	60 pc(s).	Box

BLZF 5.08/270B



Female connectors for connecting conductors with tension clamp system. The female connectors include space for labelling and can be coded. Packed in cardboard box.

- 0.20 - 2.5 mm² (IEC) / 26 - 12 AWG (UL)
- 400 V (IEC) / 300 V (UL)
- 16.5 A (IEC) / 10 A (UL)

General ordering data

Order No.	Part designation	Version	GTIN (EAN)	Qty.	Packaging
1672650000	BLZF 5.08/04/270B SN BK BX	PCB plug-in connector, female plug, 5.08 mm, No. of poles: 4, 270°, Tension clamp connection, Clamping range, max.: 3.31 mm ² , Box	4008190434366	78 pc(s).	Box
1672420000	BLZF 5.08/04/270B SN OR BX	PCB plug-in connector, female plug, 5.08 mm, No. of poles: 4, 270°, Tension clamp connection, Clamping range, max.: 3.31 mm ² , Box	4008190434137	78 pc(s).	Box

System pitch 5.08 mm (0.200 inch) SL-SMT 5.08/04/90G 3.2SN BK BX

Weidmüller Interface GmbH & Co. KG
 Klingenbergstraße 16
 D-32758 Detmold
 Germany
 Fon: +49 5231 14-0
 Fax: +49 5231 14-2083
 www.weidmueller.com

Counterpart

BLZP 5.08/225B SN



Clamping-yoke wire connection with right-angled (90° or 270°) or angled (225°) outlet direction. The female connectors provide space for labelling and can be coded. Can be fastened with flange or release latch. They feature an integrated plus/minus screw, protection against false insertion under clamping yoke. They are delivered with an opened clamping yoke.

- 0.2-2.5 mm² (IEC) / 26-12 AWG (UL)
- 400 V (IEC) / 300 V (UL)
- 17.5 A (IEC) / 10 A (UL)

General ordering data

Order No.	Part designation	Version	GTIN (EAN)	Qty.	Packaging
1945770000	BLZP 5.08/04/225B SN OR BX	PCB plug-in connector, female plug, 5.08 mm, No. of poles: 4, 225°, Clamping yoke connection, Clamping range, max.: 4 mm ² , Box	4032248621248	78 pc(s).	Box
1946000000	BLZP 5.08/04/225B SN BK BX	PCB plug-in connector, female plug, 5.08 mm, No. of poles: 4, 225°, Clamping yoke connection, Clamping range, max.: 4 mm ² , Box	4032248621521	78 pc(s).	Box

BLZP 5.08/180LR SN



Female connectors with clamping yoke screw connection for conductor connection with straight (180°) outlet direction. The female connectors provide space for labelling and can be coded. Can be fastened with flange or release latch. They feature an integrated plus/minus screw, protection against false insertion under clamping yoke. They are delivered with an opened clamping yoke.

- 0.2-2.5 mm² (IEC) / 26-12 AWG (UL)
- 400 V (IEC) / 300 V (UL)
- 19 A (IEC) / 15 A (UL)

General ordering data

Order No.	Part designation	Version	GTIN (EAN)	Qty.	Packaging
1944850000	BLZP 5.08/04/180LR SN OR BX	PCB plug-in connector, female plug, 5.08 mm, No. of poles: 4, 180°, Clamping yoke connection, Clamping range, max.: 4 mm ² , Box	4032248619450	100 pc(s).	Box
1945080000	BLZP 5.08/04/180LR SN BK BX	PCB plug-in connector, female plug, 5.08 mm, No. of poles: 4, 180°, Clamping yoke connection, Clamping range, max.: 4 mm ² , Box	4032248620227	100 pc(s).	Box

System pitch 5.08 mm (0.200 inch) SL-SMT 5.08/04/90G 3.2SN BK BX

Weidmüller Interface GmbH & Co. KG
 Klingenbergstraße 16
 D-32758 Detmold
 Germany
 Fon: +49 5231 14-0
 Fax: +49 5231 14-2083
 www.weidmueller.com

Counterpart

BLF 5.08/90F SN



Just as reliable as the tried-and-true original, with innovation in detail:

The BLF 5.0x – the PUSH-IN version of the BLZ 5.0x socket block – features a new connection system and a more compact design. Weidmüller's innovative PUSH-IN spring connection features a trend-setting, tool-free wire connection system that is simple to operate.

In terms of versatility, the BLF 5.0x offers just as much as the older versions:

- The choice of three wire outlet directions offers you proven design flexibility for your applications.
- Four flange variations, including the patented release latch, allow for user-friendly unplugging designs.

General ordering data

Order No.	Part designation	Version	GTIN (EAN)	Qty.	Packaging
1000240001	BLF 5.08/04/90F SN BK BX	PCB plug-in connector, female plug, 5.08 mm, No. of poles: 4, 90°, PUSH IN, Clamping range, max.: 3.31 mm², Box	4032248690206	60 pc(s).	Box
1002110000	BLF 5.08/04/90F SN OR BX	PCB plug-in connector, female plug, 5.08 mm, No. of poles: 4, 90°, PUSH IN, Clamping range, max.: 3.31 mm², Box	4032248694068	60 pc(s).	Box

BLZF 5.08/180LR



Female connectors for connecting conductors with tension clamp system, straight 180° outlet direction. The female connectors include space for labelling and can be coded. Packed in cardboard box.

- 0.20 - 2.5 mm² (IEC) / 26 - 12 AWG (UL)
- 400 V (IEC) / 300 V (UL)
- 17 A (IEC) / 15 A (UL)

General ordering data

Order No.	Part designation	Version	GTIN (EAN)	Qty.	Packaging
1892740000	BLZF 5.08/04/180LR SN BK BX	PCB plug-in connector, female plug, 5.08 mm, No. of poles: 4, 180°, Tension clamp connection, Clamping range, max.: 3.31 mm², Box	4032248506781	60 pc(s).	Box
1851430000	BLZF 5.08/04/180LR SN OR BX	PCB plug-in connector, female plug, 5.08 mm, No. of poles: 4, 180°, Tension clamp connection, Clamping range, max.: 3.31 mm², Box	4032248382804	60 pc(s).	Box