

Flexibility:

Hirose's IT3 mezzanine connector system is as comfortable in today's data rates of PCI-X and XAUI as it will be in tomorrow's 10+Gbps. With the ability to transmit differential, single ended and power through one package, and stackable from 15-40mm, IT3 can solve your interface needs for both current generations and future generations.

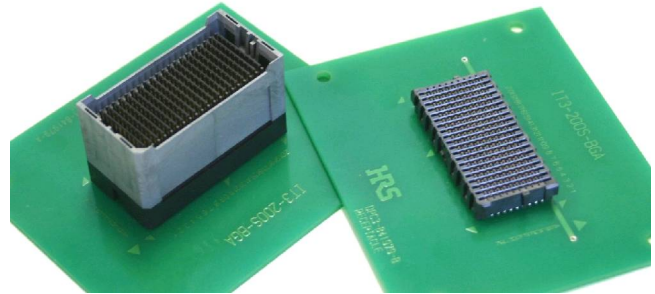

Mating receptacle : IT3D-***S-BGA(**)

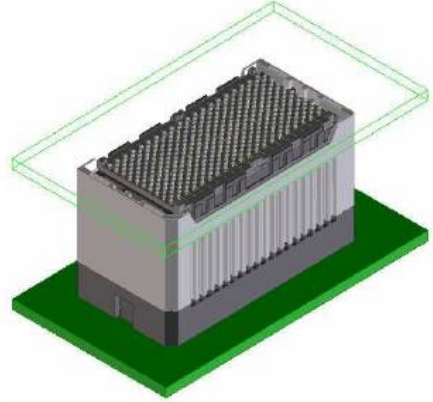
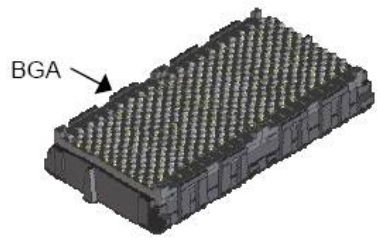

Mating Side
Mating / unmating

Interposer Assembly : IT3-***P-***H(**)

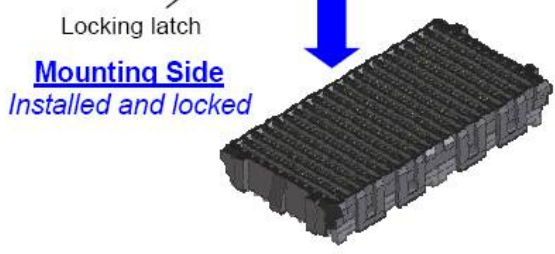
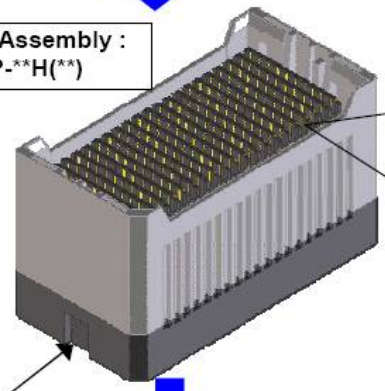

Mounting receptacle : IT3M-***S-BGA(**)

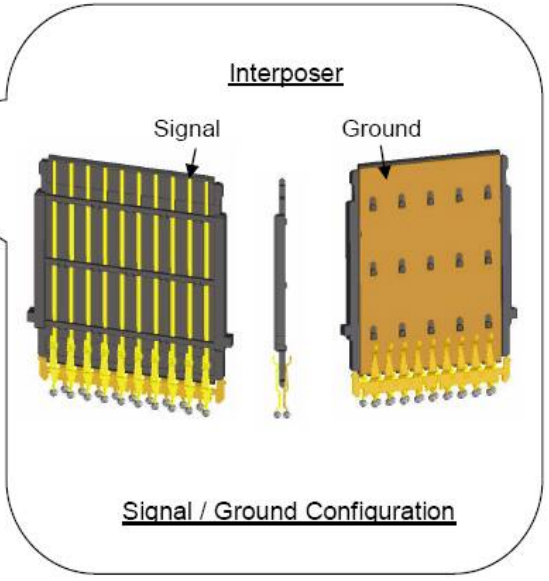

Footprint compatible with market standard:

IT3 footprint fits market standard, however, interface is not interchangeable.

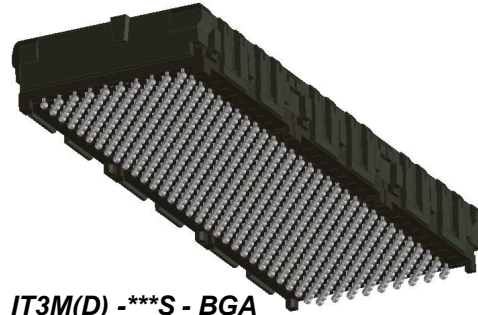

IT3M(D) - ***S - BGA

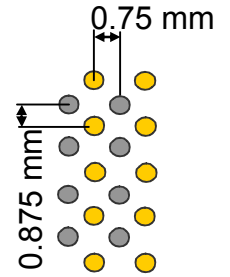

- Signal BGA land
- Ground BGA land

Great SI performance:

High-performing IT3 was designed through detailed simulation and measurement correlation for 6.25+ Gbps applications.

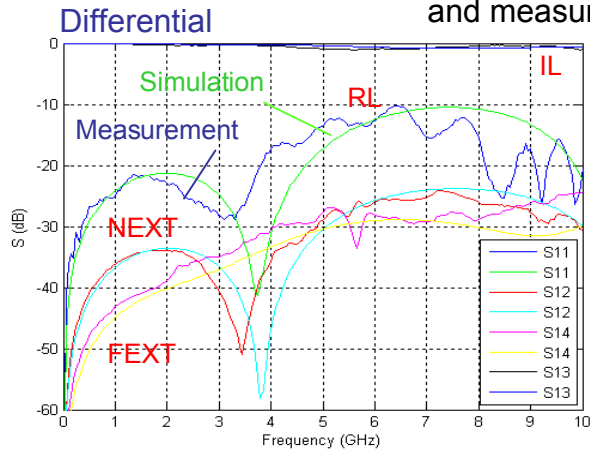

S Parameters (for IT3-17mm)

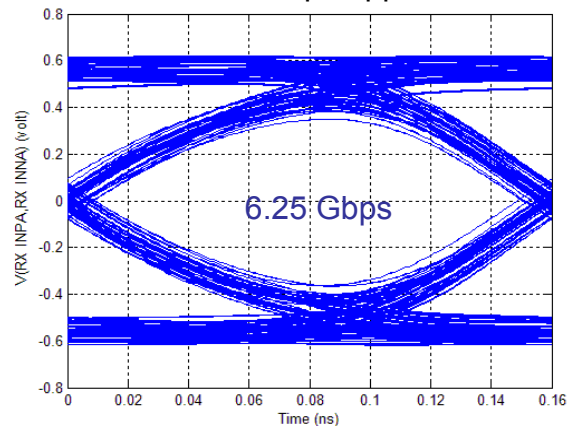

Eye Diagrams (at receiver of 6" + 6" channel)

Easy reflow process:



Any stacking height combination, receptacle is always same and its height is only 6mm.

Small size of receptacle has wide process window for reflow profile.

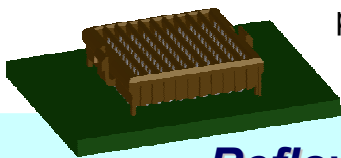

Reflow only receptacle

Variations:

	# of Pos.		
	100	200	300
15mm	P	P	P
17mm	P	A	A
20mm	P	P	P
25mm	A	A	A
26mm	A	A	A
28mm	A	A	A
30mm	P	A	A
32mm	P	A	A
38mm	P	P	P

A: Available

P: Under Planning