

DFK-MSTBVA 2,5/ 8-GF-5,08

Order No.: 1899346

The figure shows a 10-position version of the product

<http://eshop.phoenixcontact.de/phoenix/treeViewClick.do?UID=1899346>

Header, Nominal current: 12 A, Rated voltage (III/2): 320 V, Number of positions: 8, Pitch: 5.08 mm, Color: green, Metal surface: Sn, Assembly: Soldering

Commercial data	
GTIN (EAN)	 4 017918 186364
Note	Made-to-order
sales group	E120
Pack	50 pcs.
Customs tariff	85366990
Catalog page information	Page 287 (CC-2009)

Product notesWEEE/RoHS-compliant since:
09/20/2005

<http://www.download.phoenixcontact.com>
Please note that the data given here has been taken from the online catalog. For comprehensive information and data, please refer to the user documentation. The General Terms and Conditions of Use apply to Internet downloads.

Technical data	
Dimensions / positions	
Length	12 mm
Pitch	5.08 mm
Dimension a	35.56 mm
Number of positions	8

Technical data

Range of articles	DFK-MSTBVA 2,5/..-GF
Insulating material group	IIIa
Rated surge voltage (III/3)	4 kV
Rated surge voltage (III/2)	4 kV
Rated surge voltage (II/2)	4 kV
Rated voltage (III/2)	320 V
Rated voltage (II/2)	400 V
Connection in acc. with standard	EN-VDE
Nominal current I_N	12 A
Nominal voltage U_N	250 V
Maximum load current	12 A
Insulating material	PBT
Inflammability class acc. to UL 94	V0

Certificates / Approvals



Certification

CB, CUL, GOST, UL, VDE-PZI

Accessories

Item	Designation	Description
Assembly		
0708263	DFK-MSTB-SS	Screw set, for securing the header to the device wall, consists of an M3 x 10 screw, with a spring washer and a nut
1755477	MSTB-BL	Keying cap, for forming sections, plugs onto header pin, green insulating material

Plug/Adapter

1734401	CR-MSTB	Coding section, inserted into the recess in the header or the inverted plug, red insulating material
---------	---------	--

Additional products

Item	Designation	Description
General		
1873265	FKC 2,5/ 8-STF-5,08	Plug component, Nominal current: 12 A, Rated voltage (III/2): 320 V, Number of positions: 8, Pitch: 5.08 mm, Color: green, Metal surface: Sn
1902369	FKCT 2,5/ 8-STF-5,08	Plug component, Nominal current: 12 A, Rated voltage (III/2): 320 V, Number of positions: 8, Pitch: 5.08 mm, Color: green, Metal surface: Sn
1874167	FKCVR 2,5/ 8-STF-5,08	Plug component, Nominal current: 12 A, Rated voltage (III/2): 320 V, Number of positions: 8, Pitch: 5.08 mm, Color: green, Metal surface: Sn
1873867	FKCVW 2,5/ 8-STF-5,08	Plug component, Nominal current: 12 A, Rated voltage (III/2): 320 V, Number of positions: 8, Pitch: 5.08 mm, Color: green, Metal surface: Sn
1777798	FRONT-MSTB 2,5/ 8-STF-5,08	Plug component, Nominal current: 12 A, Rated voltage (III/2): 320 V, Number of positions: 8, Pitch: 5.08 mm, Color: green, Metal surface: Sn
1778043	MSTB 2,5/ 8-STF-5,08	Plug component, Nominal current: 12 A, Rated voltage (III/2): 320 V, Number of positions: 8, Pitch: 5.08 mm, Color: green, Metal surface: Sn
1809792	MSTBC 2,5/ 8-STZF-5,08	Plug component, Nominal current: 12 A, Rated voltage (III/2): 320 V, Number of positions: 8, Pitch: 5.08 mm, Color: green, Metal surface: Sn, Corresponding female crimp contacts with current [A] and conductor cross section range [mm ²] data: 10A/MSTBC-MT 0,5-1,0 (3190564); 10A/MSTBC-MT 0,5-1,0 BA (3190645); 12A/MSTBC-MT 1,5-2,5 (3190551); 12A/MSTBC-MT 1,5-2,5 BA (3190658). BA = Bandkontakte
1804661	MSTBT 2,5/ 8-STF-5,08	Plug component, Nominal current: 12 A, Rated voltage (III/2): 320 V, Number of positions: 8, Pitch: 5.08 mm, Color: green, Metal surface: Sn
1835151	MVSTBR 2,5/ 8-STF-5,08	Plug component, Nominal current: 12 A, Rated voltage (III/2): 320 V, Number of positions: 8, Pitch: 5.08 mm, Color: green, Metal surface: Sn
1834961	MVSTBW 2,5/ 8-STF-5,08	Plug component, Nominal current: 12 A, Rated voltage (III/2): 320 V, Number of positions: 8, Pitch: 5.08 mm, Color: green, Metal surface: Sn
1883417	QC 1/ 8-STF-5,08	Plug component, Nominal current: 10 A, Rated voltage (III/2): 630 V, Number of positions: 8, Pitch: 5.08 mm, Color: green, Metal surface: Sn
1853162	TMSTBP 2,5/ 8-STF-5,08	Plug component, Nominal current: 12 A, Rated voltage (III/2): 320 V, Number of positions: 8, Pitch: 5.08 mm, Color: green, Metal surface: Sn, The plug allows conductors to be looped through from module to module.

Diagrams/Drawings

Drilling plan/solder pad geometry

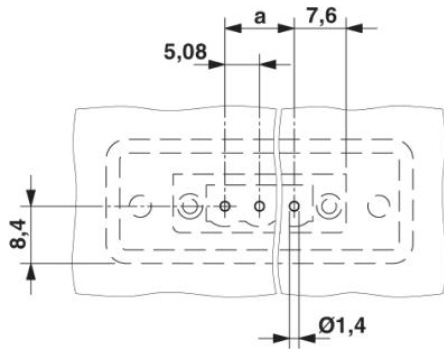

Dimensioned drawing

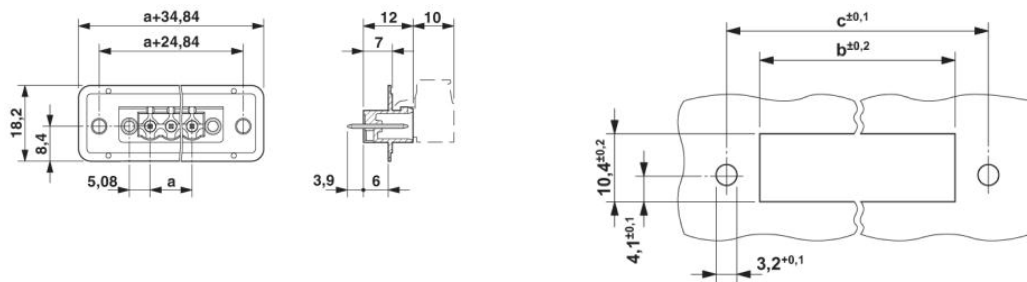

Dimension b = 10.49 mm + (no. of pos. x 5.08 mm)
Dimension c = Dim. b + 9.27 mm

Address

PHOENIX CONTACT Deutschland GmbH
Flachmarktstr. 8
32825 Blomberg, Germany
Phone +49 5235 3 12000
Fax +49 5235 3 41200
<http://www.phoenixcontact.de>



© 2010 Phoenix Contact
Technical modifications reserved;