

SPECIFICATION

Part No.	:	MA208.A.AB.001
Product Name	:	GPS/GALILEO and LTE/GSM/UMTS (4G/3G/2G 700Mhz to 960MHz/1710MHz to 2200MHz) Combination Antenna
Description	:	Adhesive Mount IP67 Antenna GPS: 3M RG-174 SMA(M) Cellular: 3M CFD-200 SMA(M) 1.8~5.5V/30dB 200.5*66.5*9mm RoHS Compliant

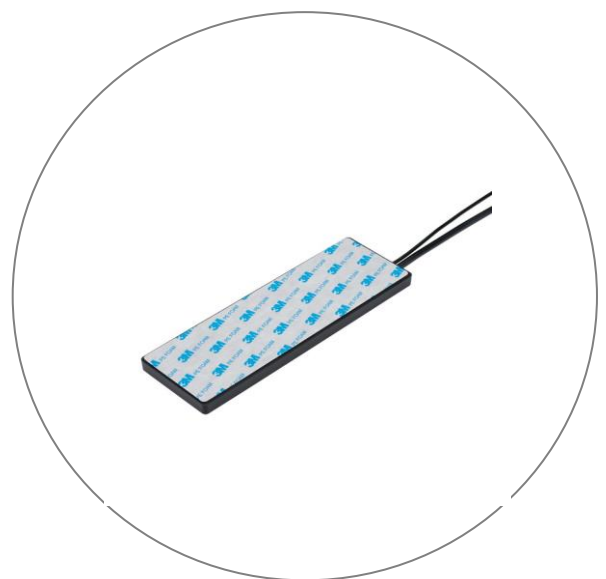

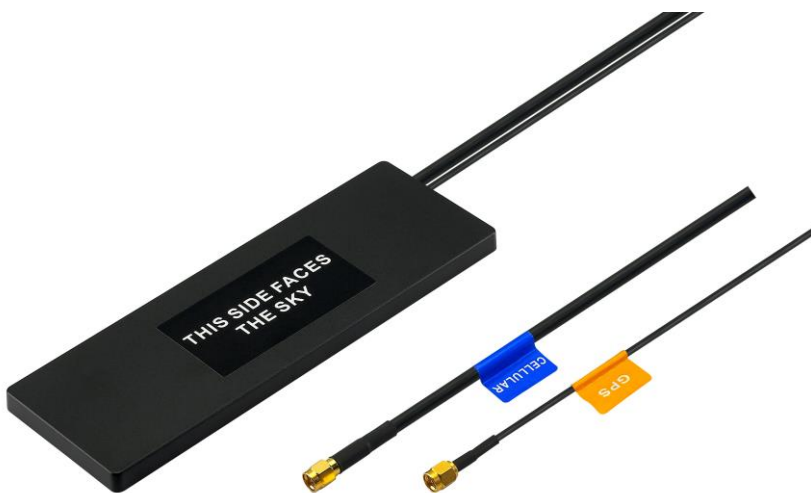

1. Introduction

The Stream MA.208 GPS/GALILEO/LTE Cellular antenna is a low profile, heavy-duty, fully IP67 waterproof external M2M antenna for use by RF professionals in telematics, transportation and remote monitoring applications. The Stream is unique in the market as it combines the highest possible efficiency and peak gain for GPS/GALILEO and all cellular bands in 4G/3G/2G in a low profile compact format for mounting via high quality first tier automotive approved 3M adhesive foam.

The patent pending design incorporates internally a custom Taoglas 35mm patch antenna on an extended integral ground-plane to deliver more than 3.5dBiC gain. A front-end SAW filter dramatically reduces radiated spurious emissions. The extended ground-plane used with an innovative internal cellular PIFA also enables the unique wide-band 4G/3G/2G response to deliver the highest performance possible, at 3 meters cable length. Nothing else out there comes close in terms of consistency of efficiency and peak gain at all cellular bands, with an awesome 70%+ at the LTE 700MHz band, again including 3 meters of cable loss. High antenna efficiencies are absolutely critical in today's 3G and 4G systems to achieving targeted data-speeds and coverage.

All this is done while still maintaining 20dB isolation between antennas. The Stream uses high-shielded PTFE dielectric ultra low-loss cables that maintain low attenuation at all frequency bands, and high noise rejection, with an average loss of only 0.3dB per meter (0.1dB per foot), compared to 0.7dB for RG58 and 1.2dB for RG174. Because of this, the Stream maximizes chances of passing PTCRB and network approvals first time. The Stream works best when attached to plastic or glass, but can also be used on metal if some foam spacing is added.

The Stream comes packaged with a separate 3M first tier automotive approved adhesive which can be attached to either the bottom or the top of the product, for easy mounting directly on glass, or on plastic.



1.1. System Configuration

This antenna specification covers the LTE/GSM/UMTS Full band for 700MHz~960MHz, 1710MHz~2170MHz and GPS (L1 Band).

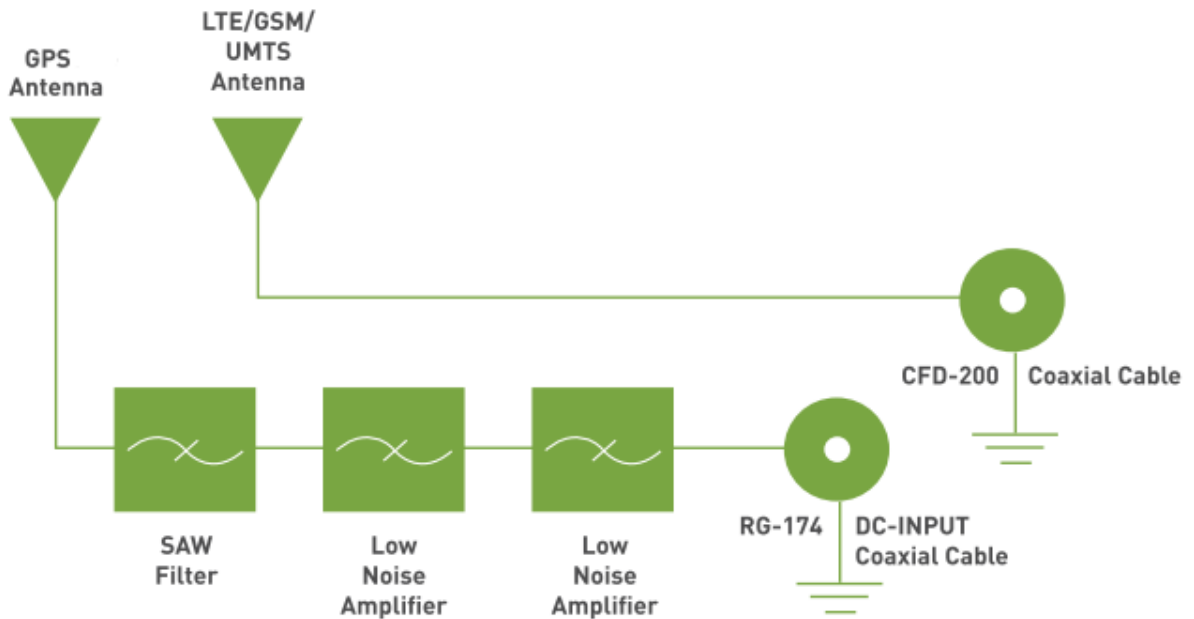

2. Specification

Performance Specifications		
Items	GPS/GALILEO Antenna	Cellular Antenna
Features	High performance GPS/GALILEO 35*35*4mm ceramic patch antenna with two stage high gain LNA 1575.42 +/- 1.023MHz	LTE – 700MHz
		CDMA: 824-896 MHz
		GSM: 880-960 MHz
		DCS: 1710-1880 MHz
		PCS: 1850-1990 MHz
		3G: 1920-2170MHz
Gain	3.5dBic typ @ Zenith	Average: - -3.03dBi at 700– 960MHz
		-4.34dBi at 1710 – 2170MHz
		Peak: 2.16dBi at 700 – 960MHz
		0.42dBi at 1710 – 2170MHz
Polarization	RHCP	Linear
VSWR		3.3 Max. at 700- 960MHz 3.6 Max. at 1710- 1850MHz 2.2 Max. at 1880-2170MHz
Impedance	50Ω	50Ω
Efficiency		≥68% @ 700MHz, ≥72% @ 750MHz, ≥66% @ 824MHz, ≥56% @ 890MHz, ≥61% @ 880MHz, ≥53% @ 960MHz, ≥37% @1710MHz, ≥51% @1880MHz, ≥55% @1990MHz, ≥54% @2110MHz, ≥45% @2170MHz

MECHANICAL		
Cable / Connector	3m RG-174 Cable SMA(M) connector Fully Customizable	CFD-200 with SMA(M) Fully customizable
Housing	UV resistant PVC	
Adhesive Mount	3M 1600SB(197.5*63.5*1.2mm)	
Protection Class	IP-67	
ENVIRONMENTAL		
Operation Temperature	-40°C to +85°C	
Storage Temperature	-40°C to +85°C	
Relative Humidity	20% to 95%	
Weight per unit	0.18kg	

***note: specifications may be subject to change**

LTE BANDS			
Band Number	LTE / LTE-Advanced / WCDMA / HSPA / HSPA+ / TD-SCDMA		
	Uplink	Downlink	Covered
1	UL: 1920 to 1980	DL: 2110 to 2170	✓
2	UL: 1850 to 1910	DL: 1930 to 1990	✓
3	UL: 1710 to 1785	DL: 1805 to 1880	✓
4	UL: 1710 to 1755	DL: 2110 to 2155	✓
5	UL: 824 to 849	DL: 869 to 894	✓
7	UL: 2500 to 2570	DL: 2620 to 2690	✗
8	UL: 880 to 915	DL: 925 to 960	✓
9	UL: 1749.9 to 1784.9	DL: 1844.9 to 1879.9	✓
11	UL: 1427.9 to 1447.9	DL: 1475.9 to 1495.9	✓
12	UL: 699 to 716	DL: 729 to 746	✓
13	UL: 777 to 787	DL: 746 to 756	✓
14	UL: 788 to 798	DL: 758 to 768	✓
17	UL: 704 to 716	DL: 734 to 746 (LTE only)	✓
18	UL: 815 to 830	DL: 860 to 875 (LTE only)	✓
19	UL: 830 to 845	DL: 875 to 890	✓
20	UL: 832 to 862	DL: 791 to 821	✓
21	UL: 1447.9 to 1462.9	DL: 1495.9 to 1510.9	✓
22	UL: 3410 to 3490	DL: 3510 to 3590	✗
23	UL: 2000 to 2020	DL: 2180 to 2200 (LTE only)	✓
24	UL: 1625.5 to 1660.5	DL: 1525 to 1559 (LTE only)	✓
25	UL: 1850 to 1915	DL: 1930 to 1995	✓
26	UL: 814 to 849	DL: 859 to 894	✓
27	UL: 807 to 824	DL: 852 to 869 (LTE only)	✓
28	UL: 703 to 748	DL: 758 to 803 (LTE only)	✓
29	UL: -	DL: 717 to 728 (LTE only)	✓
30	UL: 2305 to 2315	DL: 2350 to 2360 (LTE only)	✗
31	UL: 452.5 to 457.5	DL: 462.5 to 467.5 (LTE only)	✗
32	UL: -	DL: 1452 - 1496	✓
35		1850 to 1910	✓
38		2570 to 2620	✗
39		1880 to 1920	✓
40		2300 to 2400	✓
41		2496 to 2690	✗
42		3400 to 3600	✗
43		3600 to 3800	✗

*Covered bands represent an efficiency greater than 20%

3. Antenna Characteristics

3.1. Axial Ratio

3.1.1. With IPEX Cable

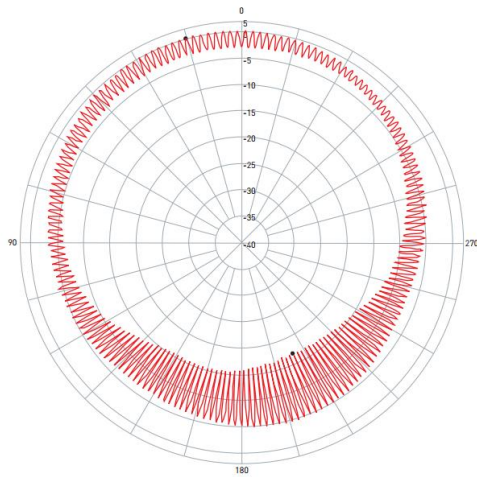

Pattern	Model No.	Test Mode	Freq [MHz]	Max Gain[dBi]	Min Gain[dBi]	Avg. Gain[dBi]	Source Polar.
1	MA208.A.AB.001	Axial Ratio	1575.42	0.06 / 15.14	-16.87 / 204.77	-4.51	CP

3.1.2. 3M CFD-200 Cable

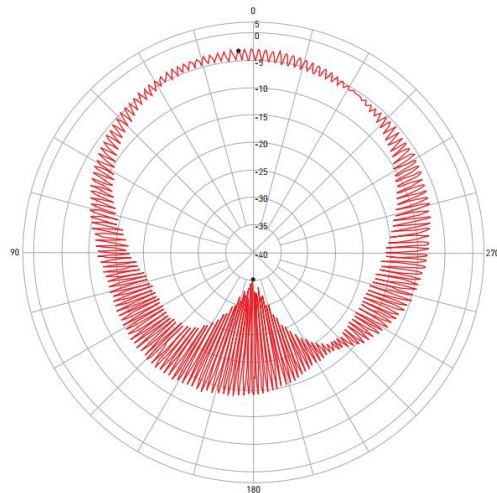

Pattern	Model No.	Test Mode	Freq [MHz]	Max Gain[dBi]	Min Gain[dBi]	Avg. Gain[dBi]	Source Polar.
1	MA208.A.AB.001	Axial Ratio	1575.42	-3.19 / 4.61	-34.89 / 178.75	-8.79	CP

3.2. Radiation Patterns

XZ Plane

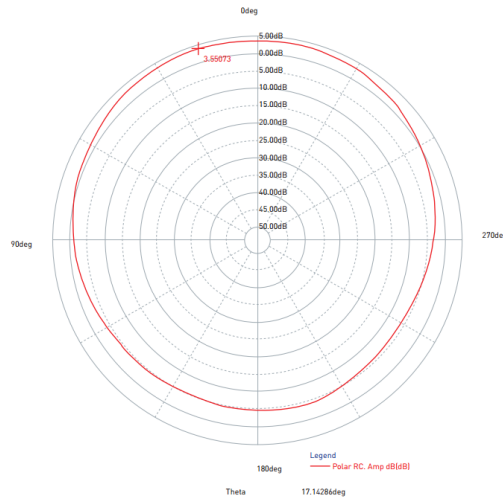

YZ Plane

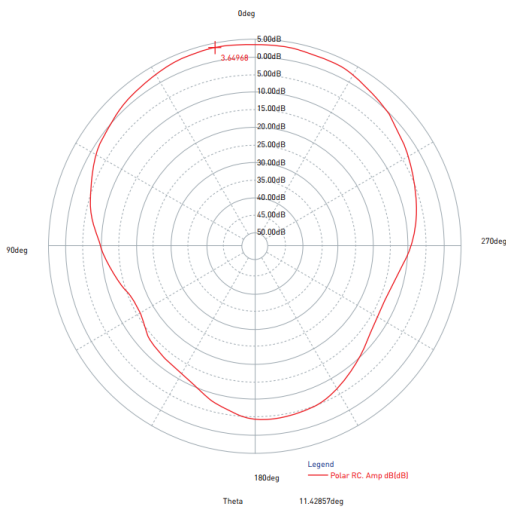

XY Plane

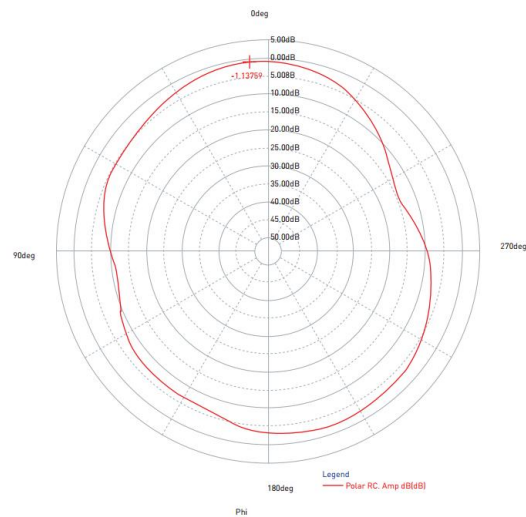

3.3. VSWR

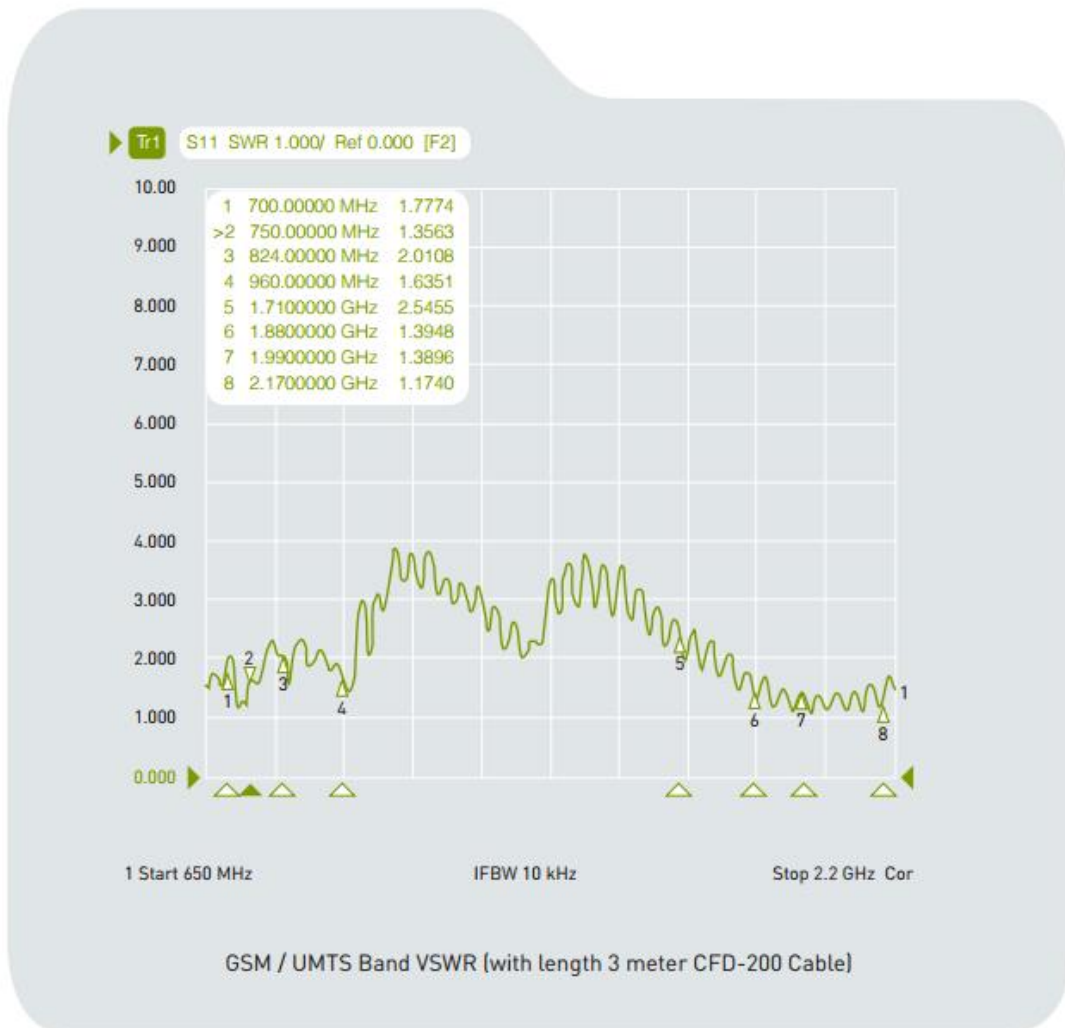

3.4. Efficiency

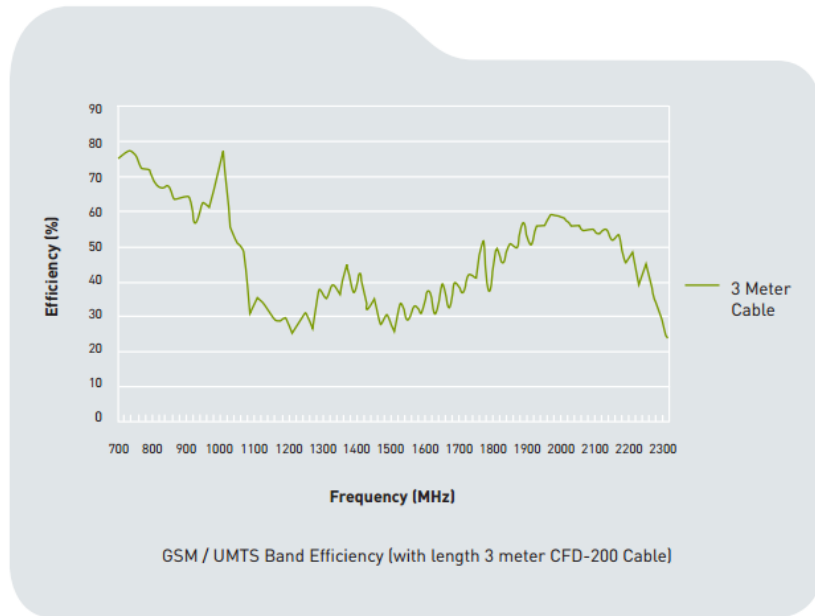

3.5. Average Gain

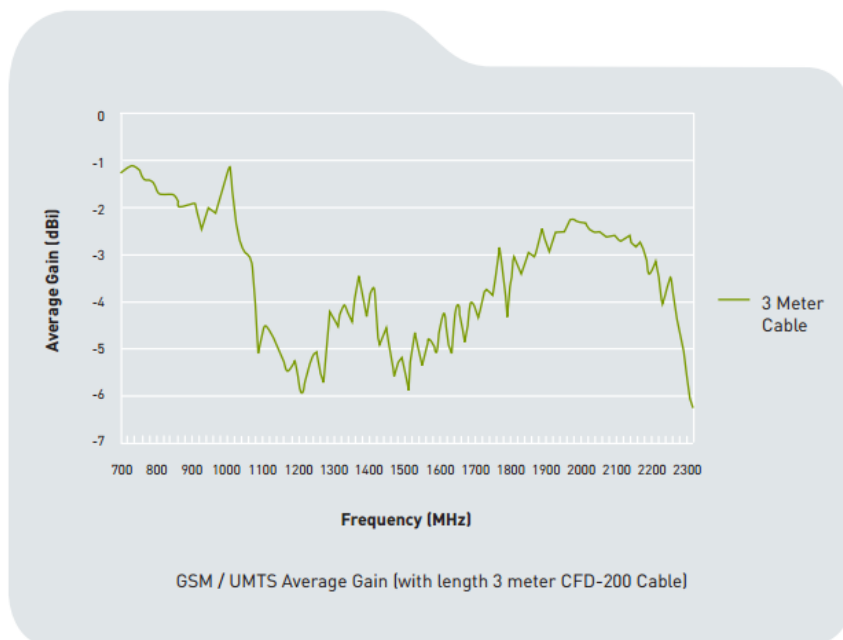

3.6. Peak Gain

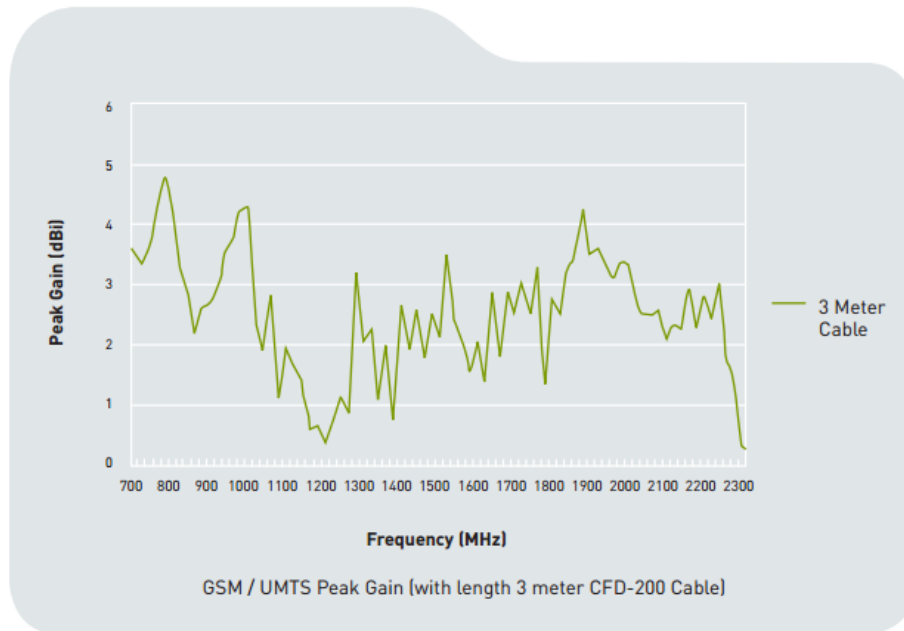

3.7. LNA

Frequency Range	1575.42+/-1.023Mhz
Output Impedance	50 Ohm
Output Power at 1dB Compression Point	-35dBm typ.
Output VSWR	2.0 Max.

Supply Voltage	Gain(Typ)	Noise Figure(Typ)	Power Consumption (Typ.)
1.8V	27.0dB	2.2dB	5.5mA
3.0V	32.9dB	2.3dB	12.5mA
5.5V	33.8dB	2.5dB	15.0mA

3.8. LNA Noise Figure at 3.0V

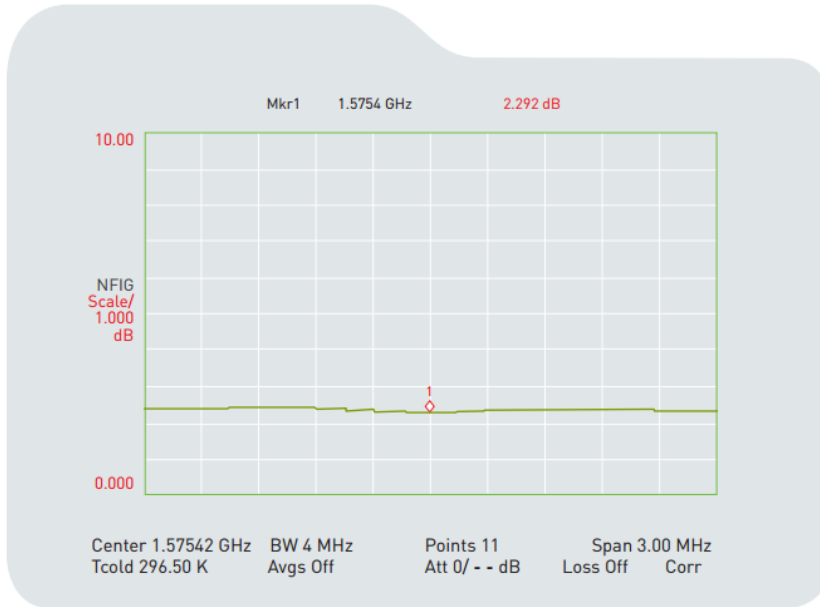

3.9. LNA Gain and Output of VSWR at 3.0V

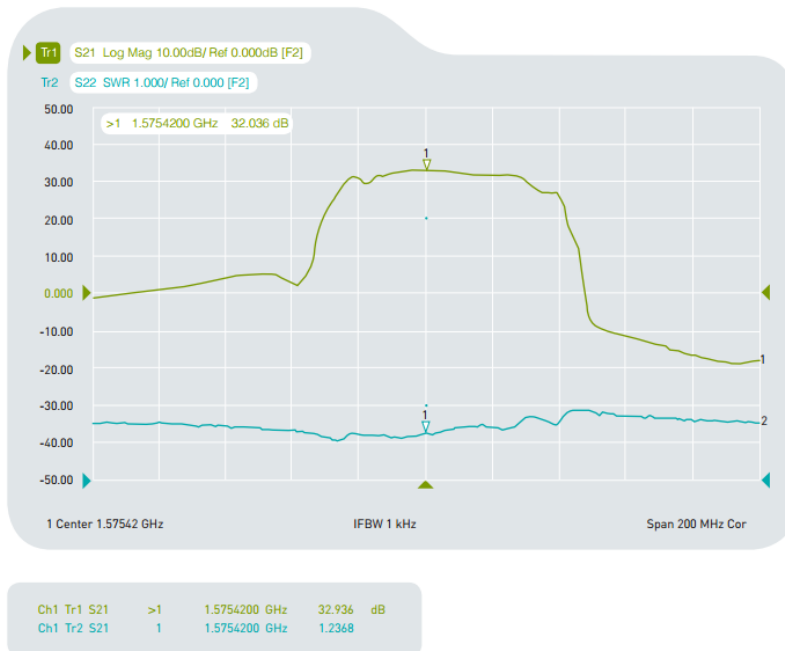

3.10. GPS/GALILEO Antenna Specifications (Through Antenna, LNA and Cable Assembly)

Frequency Range	1575.42+/-1.023Mhz
Gain at 3.0V	32.5dBic @ Zenith
Output Impedance	50 Ohm
Output VSWR	2.0 Max.

3.11. 20dB min isolation to GPS/GALILEO LNA input and LTE/ GSM/ UMTS ANTENNA

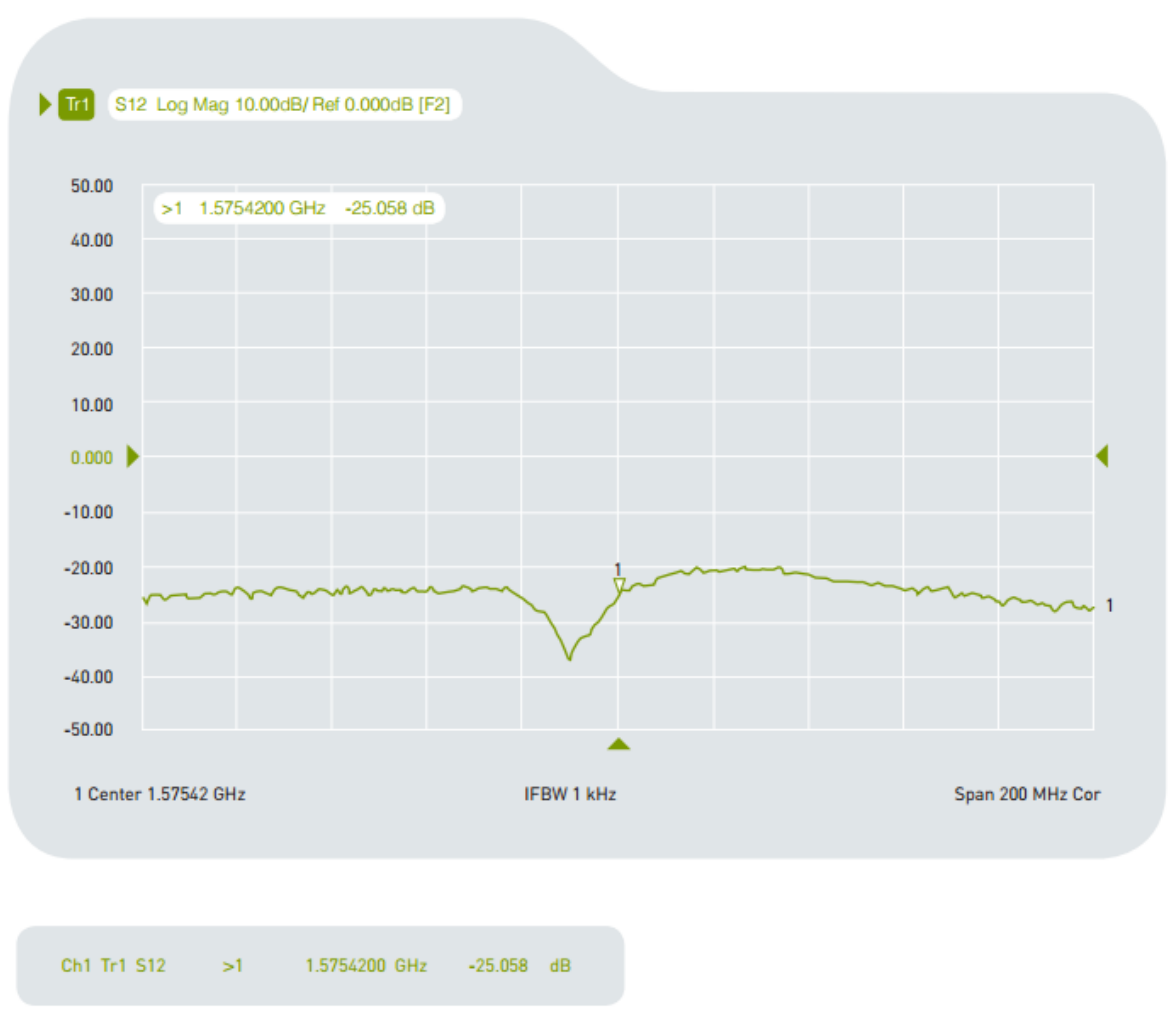

4. Drawing

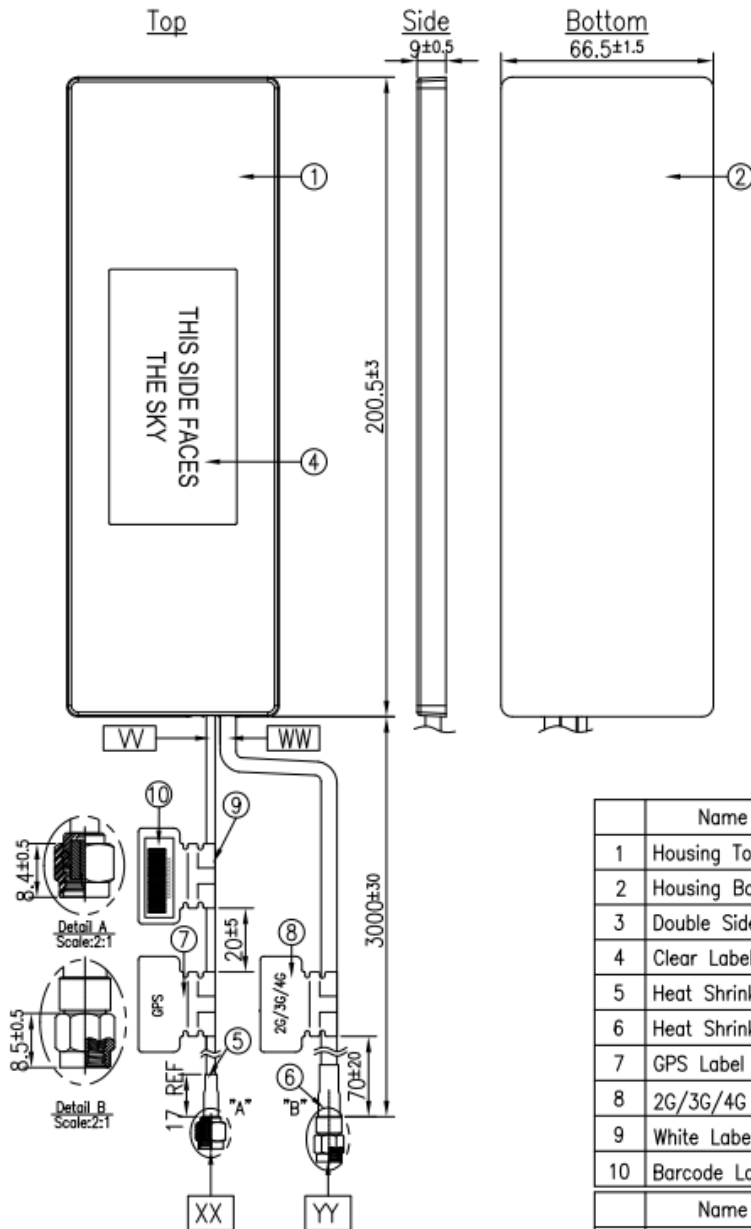

	Name	Material	Finish	QTY
1	Housing Top	ABS	Black	1
2	Housing Bottom	ABS	Black	1
3	Double Sided Adhesive Foam	3M 1600SB	Green Liner	1
4	Clear Label	PET	Black	1
5	Heat Shrink Tube	PE	Black	1
6	Heat Shrink Tube	PE	Black	1
7	GPS Label	Coated Paper	Orange	1
8	2G/3G/4G Label	Coated Paper	White	1
9	White Label (48x30)	PET	White	1
10	Barcode Label (25x9)	PET	White	1

	Name	Spec	Finish	QTY
W	Cable Type	RG174	Black	1
WW	Cable Type	CFD-200	Black	1
XX	Connector Type	SMA(M)ST	Au Plated	1
YY	Connector Type	SMA(M)ST	Au Plated	1

4.1. Separate Adhesive Pad

Double Sided Adhesive Foam

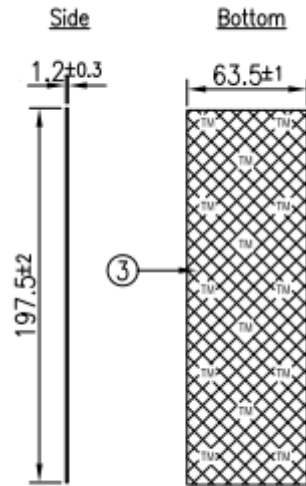

5. SPQ Packing



① P/N: Taoglas
② SPQ QTY: SPQ
③ Unit:

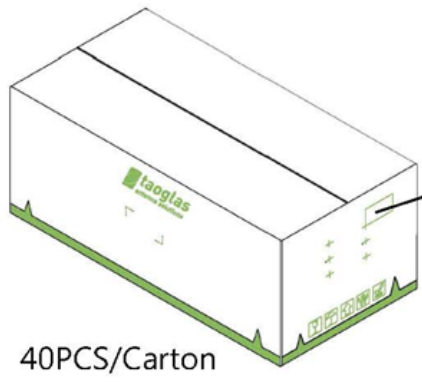
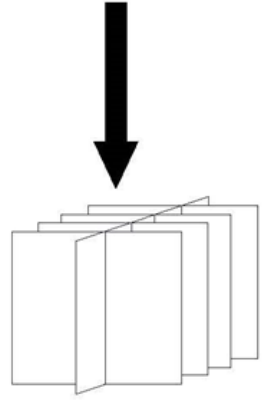

(740x370x300mm)



6. Packaging

2 pc MA208.A.AB.001 per carton
 Carton Dimensions - 300*200mm
 Total Weight - 260g

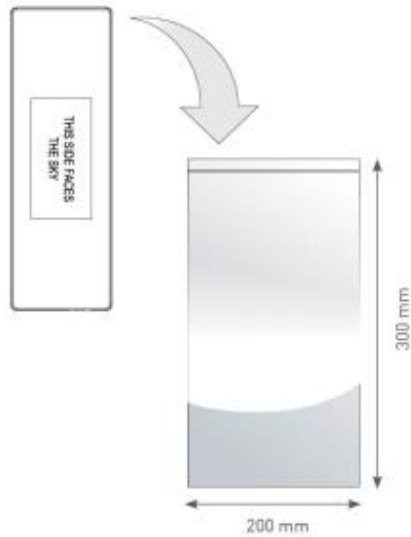

50 pcs MA208.A.AB.001 per carton
 Carton Dimensions - 740*370*300mm
 Total Weight - 14.4kg

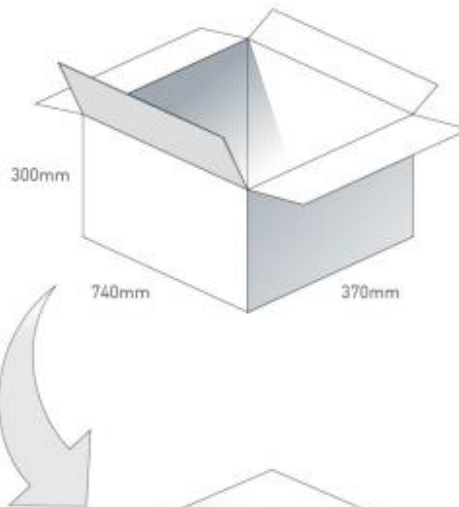

Pallet Dimensions 1200mm*1000mm*1350mm
 16 Cartons per pallet
 4 Cartons per layer
 4 Layers

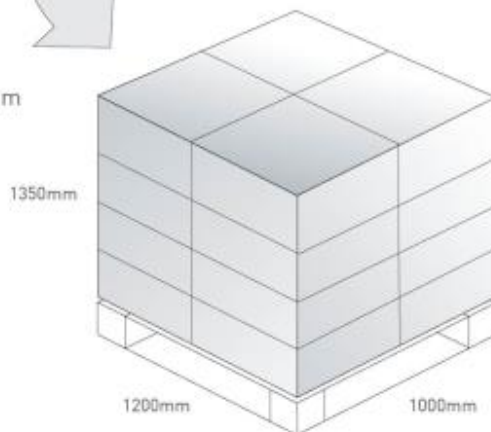



Taoglas makes no warranties based on the accuracy or completeness of the contents of this document and reserves the right to make changes to specifications and product descriptions at any time without notice. Taoglas reserves all rights to this document and the information contained herein.

Reproduction, use or disclosure to third parties without express permission is strictly prohibited.

Copyright © Taoglas Ltd.