



STPR620CT/CF/CFP

ULTRA FAST RECOVERY RECTIFIER DIODES

MAIN PRODUCT CHARACTERISTICS

$I_{F(AV)}$	2 x 3 A
V_{RRM}	200 V
$T_{j(max)}$	150°C
$V_{F(max)}$	0.99 V
$t_{rr(max)}$	30 ns

FEATURES

- Suited for SMPS
- Low losses
- Low forward and reverse recovery time
- High surge current capability
- Insulated packages:
ISOWATT220AB / TO-220FPAB
Insulation voltage = 2000V DC
Capacitance = 12pF

DESCRIPTION

Low cost dual center tap rectifier suited for Switched Mode Power Supplies and high frequency DC to DC converters.

Packaged in TO-220AB, TO-220FPAB and ISOWATT220AB, this device is intended for use in low voltage, high frequency inverters, free wheeling and polarity protection applications.

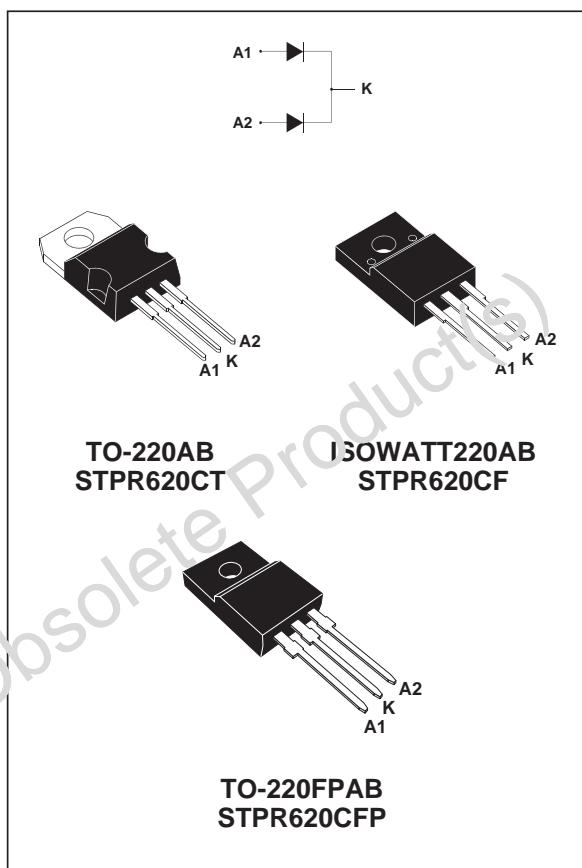

ABSOLUTE MAXIMUM (limiting values)

Symbol	Parameter			Value	Unit
V_{RRM}	Repetitive peak reverse voltage			200	V
$I_{F(RMS)}$	RMS forward current		Per diode	10	A
$I_{F(AV)}$	Average forward current $\delta = 0.5$	TO-220AB	$T_c = 125^\circ\text{C}$	Per diode	3
		ISOWATT220AB TO-220FPAB	$T_c = 120^\circ\text{C}$	Per device	6
I_{FSM}	Surge non repetitive forward current		$t_p = 10\text{ms}$ sinusoidal	30	A
T_{stg}	Storage temperature range			- 65 to + 150	°C
T_j	Maximum junction temperature			150	°C

STPR620CT/CF/CFP

THERMAL RESISTANCES

Symbol	Parameter		Value	Unit	
R _{th(j-c)}	Junction to case	TO-220AB	Per diode	6.5	°C/W
		ISOWATT220AB TO-220FPAB	Per diode	8.5	

When the diodes 1 and 2 are used simultaneously :

$$\Delta T_j(\text{diode 1}) = P(\text{diode 1}) \times R_{th(j-c)} (\text{Per diode}) + P(\text{diode 2}) \times R_{th(c)}$$

ELECTRICAL CHARACTERISTICS

STATIC CHARACTERISTICS

Symbol	Test Conditions		Min.	Typ.	Max.	Unit
I _R *	T _j = 25°C	V _R = V _{RRM}			50	μA
	T _j = 100°C				0.6	mA
V _F **	T _j = 125°C	I _F = 3 A			0.99	V
	T _j = 125°C	I _F = 6 A			1.20	
	T _j = 25°C	I _F = 6 A			1.25	

Pulse test :

* tp = 5 ms, δ < 2 %

** tp = 380 μs, δ < 2 %

RECOVERY CHARACTERISTICS

Symbol	Test Conditions		Min.	Typ.	Max.	Unit
t _{rr}	T _j = 25°C	I _F = 0.5A I _R = 1A			30	ns
t _{fr}	T _j = 25°C	I _F = 1A V _{FR} = 1.1 x V _F		20		ns
V _{FP}	T _j = 25°C	I _F = 1A		3		V

To evaluate the conduction losses use the following equation :

$$P = 0.78 \times I_{F(AV)} + 0.070 \times I_{F(RMS)}^2$$

Fig. 1: Average forward power dissipation versus average forward current (Per diode).

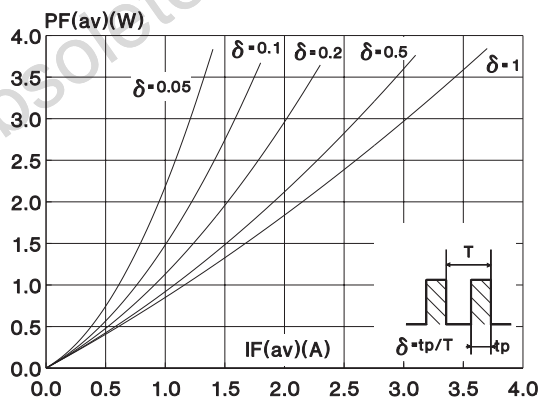

Fig. 2: Peak current versus form factor (Per diode).

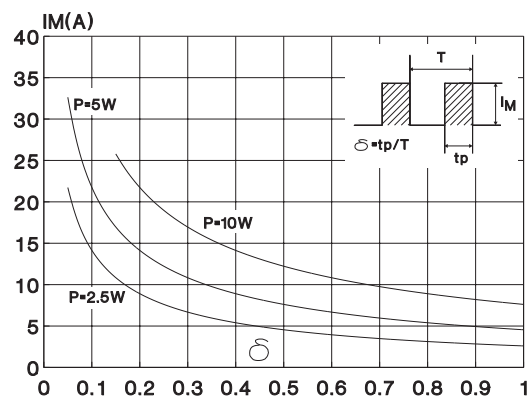

Fig. 3: Average current versus ambient temperature. (duty cycle: 0.5) (TO-220AB)

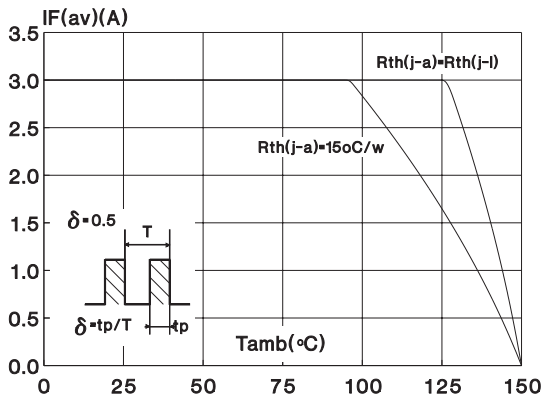

Fig. 4: Average current versus ambient temperature. (duty cycle : 0.5) (ISOWATT220AB / TO-220FPAB)

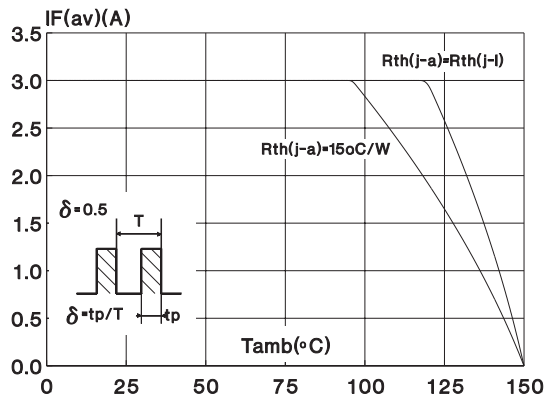

Fig. 5: Non repetitive surge peak forward current versus overload duration (Maximum values) (Per diode) (TO-220AB).

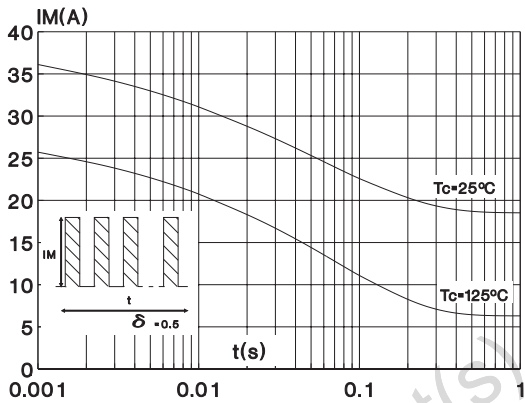

Fig. 6: Non repetitive surge peak forward current versus overload duration (Maximum values) (Per diode) (ISOWATT220AB / TO-220FPAB).

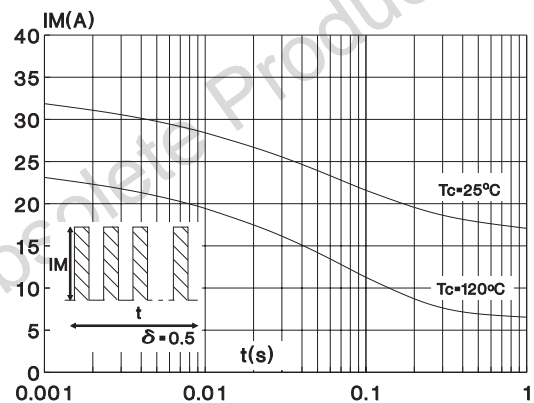

Fig. 7: Relative variation of thermal transient impedance junction to case versus pulse duration (Per diode) (TO-220AB).

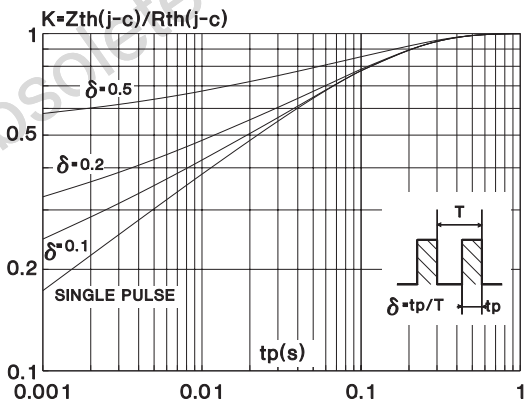

Fig. 8: Relative variation of thermal transient impedance junction to case versus pulse duration (Per diode) (ISOWATT220AB / TO-220FPAB).

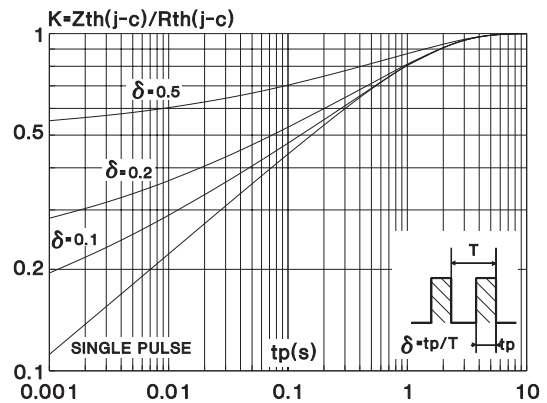

Fig. 9: Forward voltage drop versus forward current. (Maximum values) (Per diode).

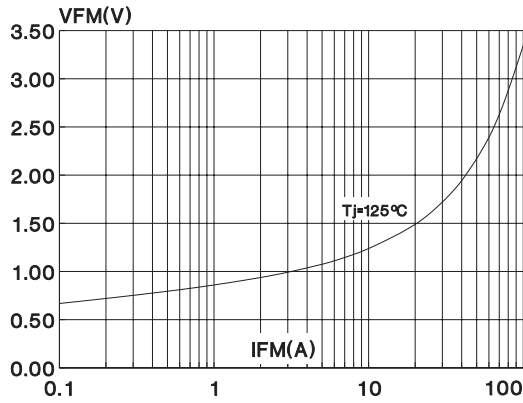

Fig. 10: Junction capacitance versus reverse voltage applied (Typical values) (Per diode).

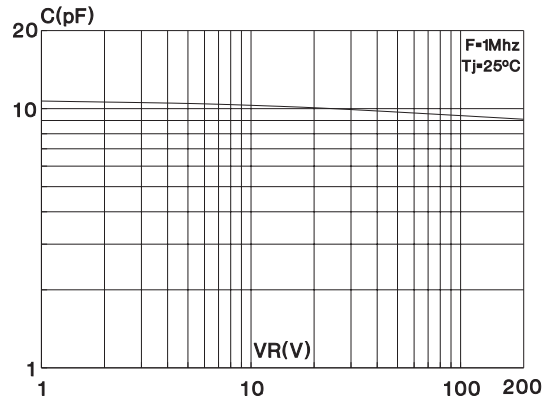

Fig. 11: Recovery charges versus dI_F/dt (Per diode).

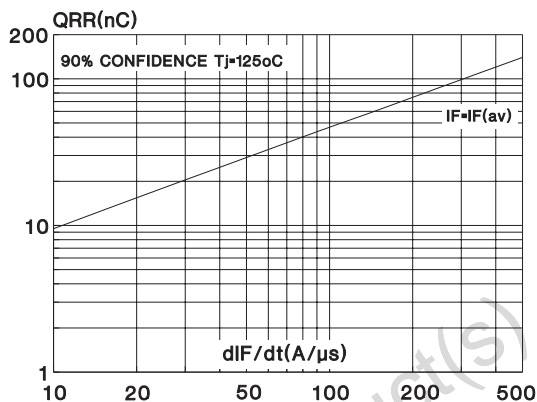

Fig. 12: Peak reverse current versus dI_F/dt (Per diode).

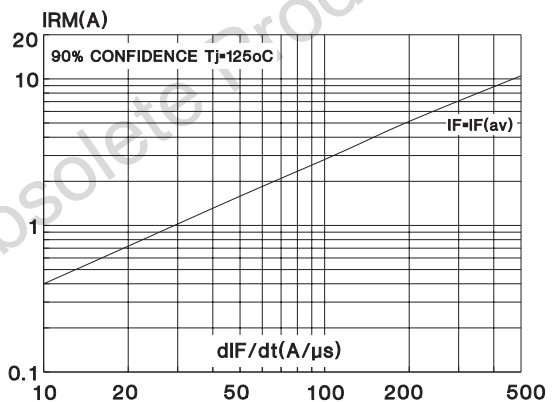
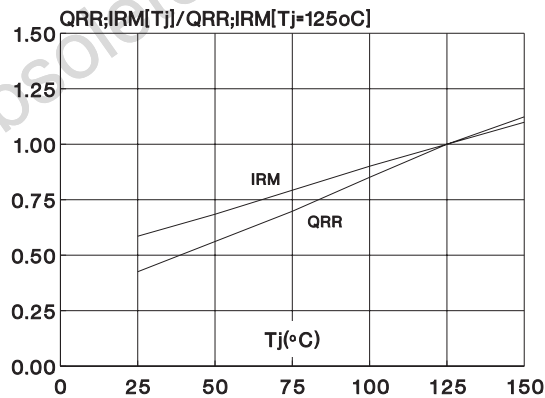
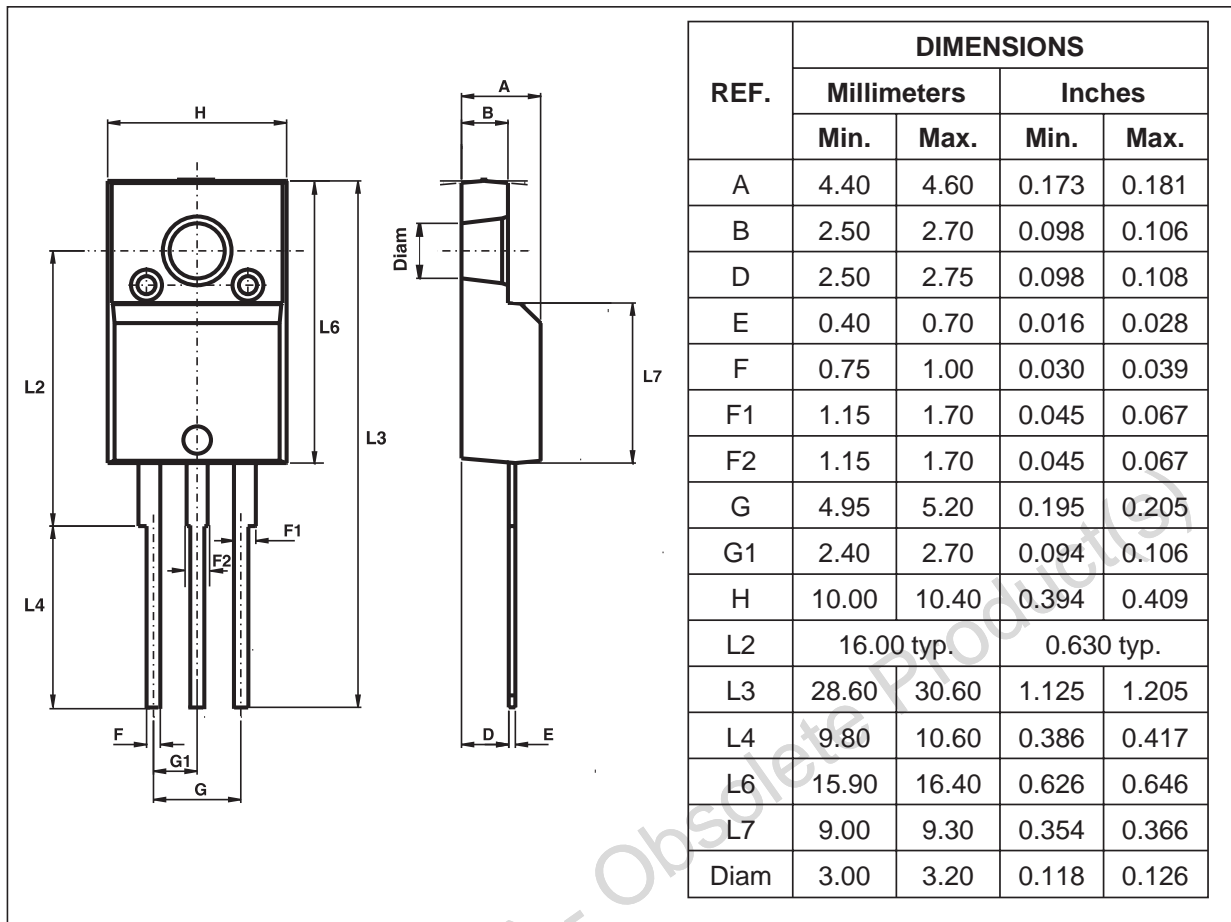

Fig. 13: Dynamic parameters versus junction temperature (Per diode).



PACKAGE MECHANICAL DATA
ISOWATT220AB (JEDEC outline)



STPR620CT/CF/CFP

PACKAGE MECHANICAL DATA
TO-220FPAB

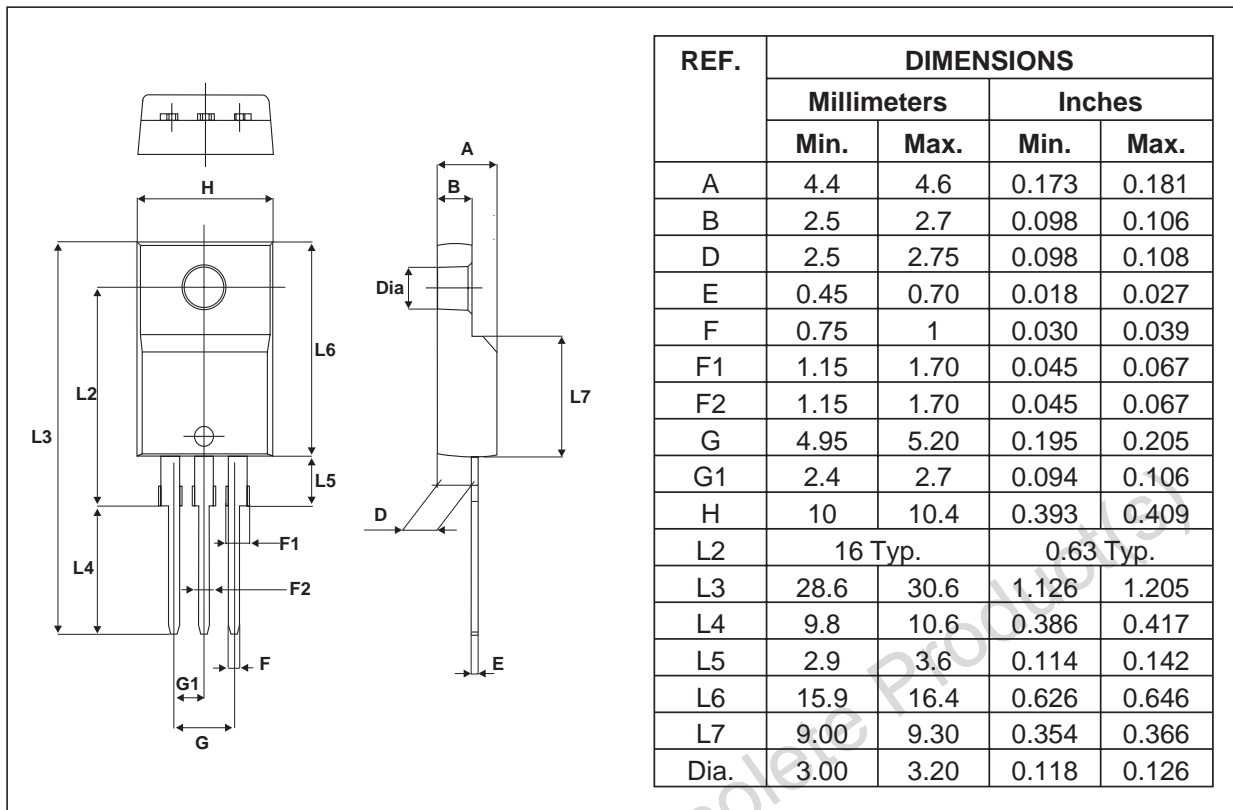

- Cooling method : by conduction (C)
- Recommended torque value (ISOWATT220AB, TO-220FPAB): 0.55 Nm
- Maximum torque value (ISOWATT220AB, TO-220FPAB): 0.7 Nm
- Recommended torque value (TO-220AB): 0.8 Nm
- Maximum torque value (TO-220AB): 1.0 Nm
- Epoxy meets UL94, V0

PACKAGE MECHANICAL DATA
TO-220AB (JEDEC outline)

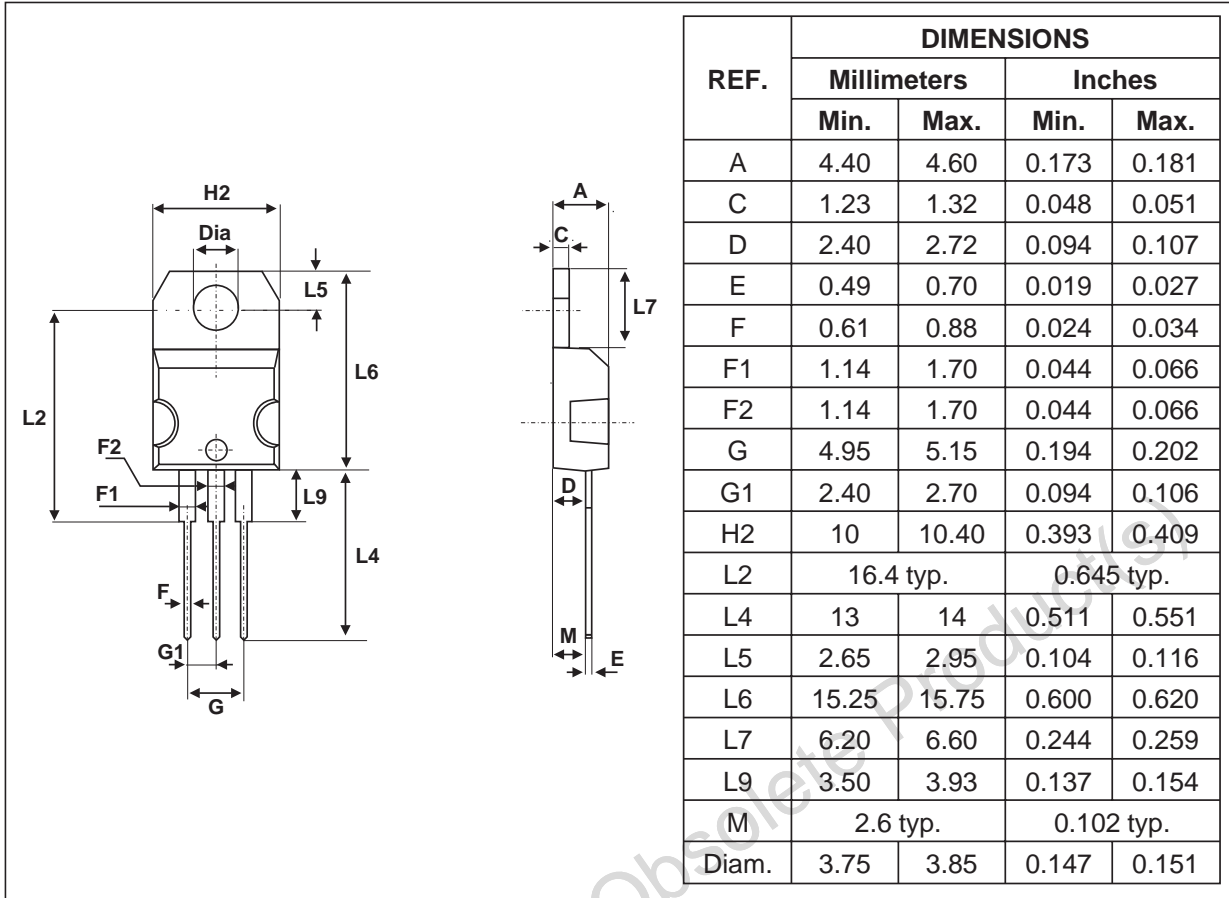

Type	Marking	Package	Weight	Base Qty	Delivery mode
STPR620CT	STPR620CT	TO-220AB	2.23 g	50	Tube
STPR620CF	STPR620CF	ISOWATT220AB	2.2 g	50	Tube
STPR620CFP	STPR620CFP	TO-220FPAB	2 g	50	Tube

Information furnished is believed to be accurate and reliable. However, STMicroelectronics assumes no responsibility for the consequences of use of such information nor for any infringement of patents or other rights of third parties which may result from its use. No license is granted by implication or otherwise under any patent or patent rights of STMicroelectronics. Specifications mentioned in this publication are subject to change without notice. This publication supersedes and replaces all information previously supplied. STMicroelectronics products are not authorized for use as critical components in life support devices or systems without express written approval of STMicroelectronics.

The ST logo is a registered trademark of STMicroelectronics
 © 2002 STMicroelectronics - Printed in Italy - All rights reserved.
 STMicroelectronics GROUP OF COMPANIES
 Australia - Brazil - Canada - China - Finland - France - Germany
 Hong Kong - India - Israel - Italy - Japan - Malaysia - Malta - Morocco - Singapore
 Spain - Sweden - Switzerland - United Kingdom - United States.

<http://www.st.com>

